

AVer
www.aver.com

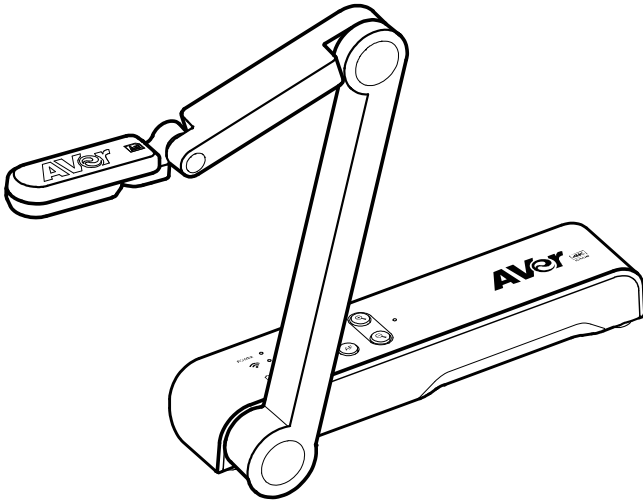

M15W

4K
ULTRA HD

Instruction Manual • 安裝指南
取扱説明書 • Bedienungsanleitung
Mode d'emploi • Manual de instrucciones
Manuale d'uso

English.....	1
繁體中文.....	16
日本語.....	30
Deutsch.....	41
Français.....	54
Español.....	68
Italiano.....	81

Package Contents

The items below are included with this product. If any item is missing, contact the dealer from whom you purchased this product.

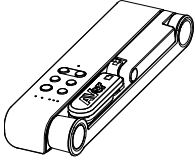

M15W unit

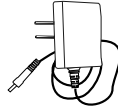

Power adapter/ Power plug



USB cable



Warranty card*



Instruction manual

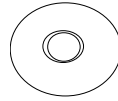

Software CD**



Wi-Fi Dongle
(Optional)

*Only for Japan, Taiwan, and Europe

**Only for Japan and Europe

Optional Accessories



Carrying bag



Anti-glare sheet

More Help

For FAQs, technical support, software and instruction manual download, please visit:

Global:

<http://presentation.aver.com/download-center/>

Technical Support:

<https://aver.com/technical-support>

Hardware Parts

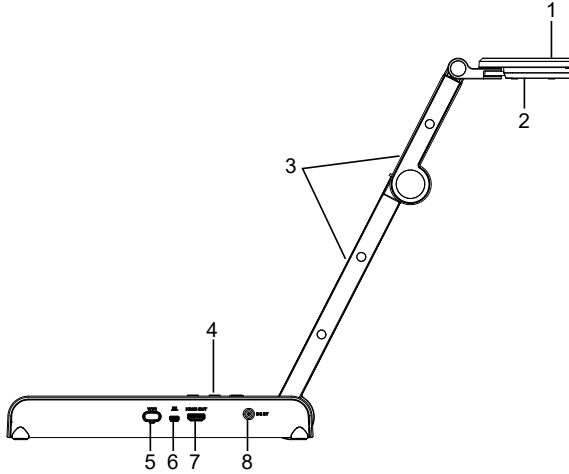

1. Camera head	2. LED lighting
3. Arm	4. Control panel
5. Wi-Fi dongle	6. USB port
7. HDMI output	8. DC power jack

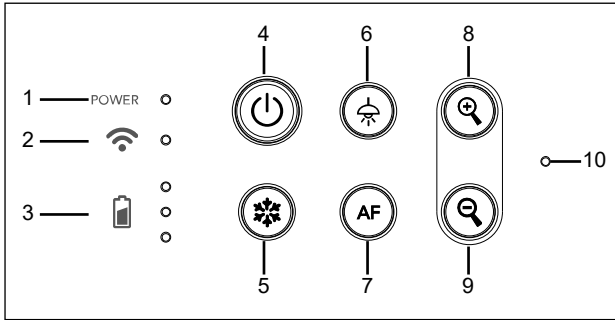

Control Panel



- | | |
|--------------------------------------|------------------|
| 1. Power indicator | 6. Lamp(on/off) |
| 2. Wi-Fi indicator | 7. Auto focus |
| 3. Battery indicator | 8. Zoom in |
| 4. Power button
(on/off/standby*) | 9. Zoom out |
| 5. Freeze | 10. Built-in MIC |

* Standby mode is supported when power plugged in.

LED Indicator

Power	Solid green: Power on No light: Power off Solid red: Standby mode* * Standby mode is supported when power plugged in.
Wi-Fi 	Solid blue: AP Mode Ready / STA connected Slow flashing blue: Software connection with camera Short flashing blue: Create AP mode / STA connecting Solid green: Miracast mode ready Slow flashing green: Miracast streaming start Quick flashing green: Miracast device scan / connecting
Battery 	Solid green(x3): Battery is full(100% ~ 60%) Solid green(x2): Battery is 60% ~ 30% Solid green(x1): Battery is 30% ~ 5% Solid red (x1): Battery is 5% ~ 0% Flashing red (x1): Battery is out of power Solid orange(x3): Battery is abnormal

[Note]

The battery will be exhausted for long-term usage. Do not replace the battery yourself. Please contact your dealer.

Compound Key

Press and hold for 3 seconds to operate the compound key function.



MORE INFO / BATTERY : Display system information and battery power status.



CAPTURE : Snapshot the current screen image to software or cloud.

Press keys to operate the compound key function.

FACTORY RESET



+ : Back to factory default settings.

RESOLUTION



: Press to switch between following modes:

- Auto detects the best resolution(4K, 720P, 1080P)
- 1024x768 (If HDMI device support)
- 4K 60Hz (If HDMI device support)

MODE



:Press to switch between following modes:

- Normal: Adjust the gradient of image.
- Motion: Increase frame rate. Sufficient lighting is required when using this mode.
- High quality: Better image quality.

Device Connection

1

Plug in power adapter and turn on M15W.

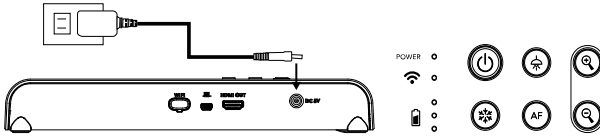

[Note]

- Please fully charge the camera for the first time use.
- When the camera is power on, the camera is in "Standby" mode. In standby mode, it can be charging with the USB connection between other devices; but the power supply is required 5V2A and the charging time will be longer.
- The laptop, projector, or monitor **cannot** provide the power through the USB connection to the camera while the camera is operating.
- When the camera is charging with the wall outlet, the battery indicator is in green flashing.
- Press (AF) + (Q) to reboot when the camera doesn't work properly.

2

Connect M15W to laptop and HDMI display.

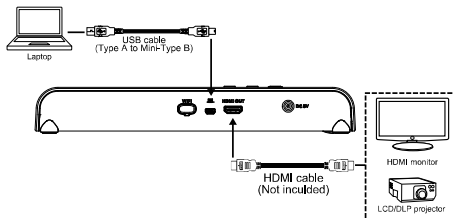



[Note]

- The Wi-Fi mode is on when the camera is powered up.
- When camera connects to a laptop through the USB port, the Wi-Fi mode is disabled. Please follow the direction on HDMI device.

P2P connection via Wi-Fi Dongle(Optional)

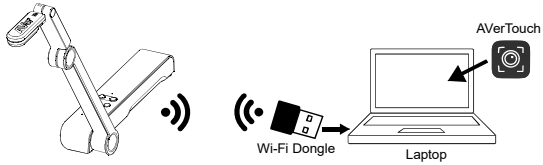
- 1 **Plug-in the WiFi dongle to PC/laptop and Install the AVerTouch application.**



- 2 **Open AVerTouch application, click  to connect the camera.**

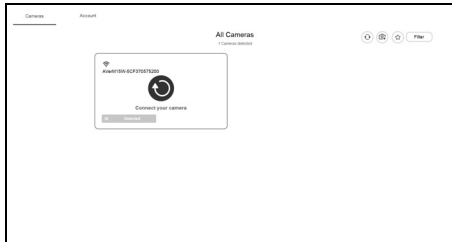

[Note] Check serial number at bottom of the camera to find your camera.

- 3 **Click Next to continue.**

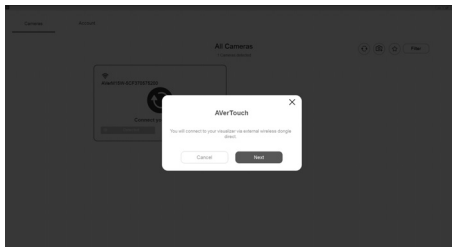

4

Entering the Camera Name and Passcode, click Done to continue.

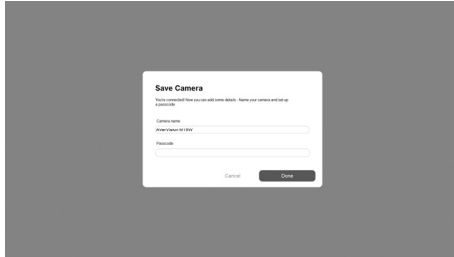

5

Click Done button to connect camera.



[Note] It takes about 60 seconds to complete connection.

6

Select X can exit the live view page.



[Note] When connecting is successful, you should see the live view of the camera.

Wi-Fi Connection

1 Power on the camera.

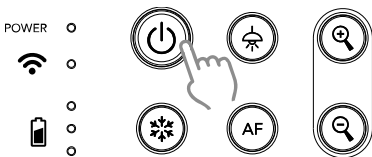

POWER ○
Wi-Fi ○
Battery ○

Power button (with hand icon), Wi-Fi, AF, Zoom in, Zoom out

Check the Wi-Fi status – Blue light on.

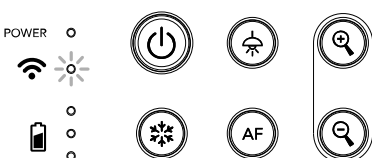

POWER ○
Wi-Fi (with blue light) ○
Battery ○

Power button, Wi-Fi, AF, Zoom in, Zoom out

2 Open AVerTouch and follow on-screen instruction to enable Wi-Fi function on camera.

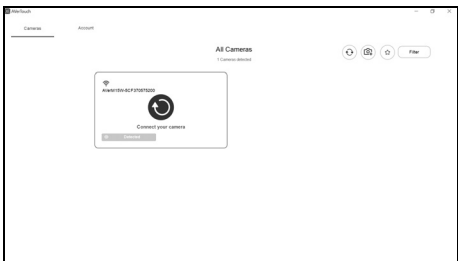

The screenshot shows the AVerTouch software interface. At the top, it says "All Cameras" and "1 Camera detected". Below this, there is a central panel with the AVerTouch logo and a "Connect your camera" button. The interface also includes navigation icons (back, forward, search) and a "Help" button.

[Note]

- The software will auto detect the camera on your network.
- Select the camera that you want to connect with it.
- The camera name will be "AVer 'model name' - WiFi dongle Mac address". The Mac address will be different from the device.

Wi-Fi Connection(Cont.)

3

Select  to make a connection with camera.

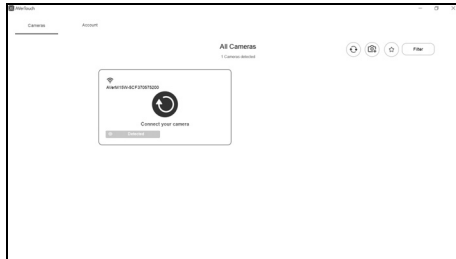

4

Select  to switch to camera live screen.

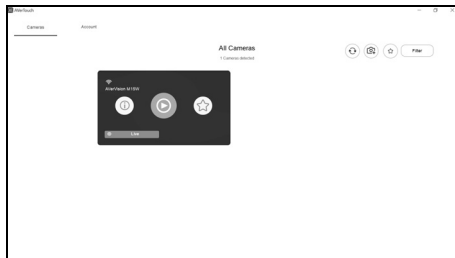

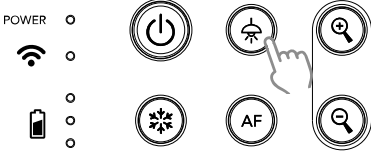

Miracast Connection

1 Press  to enter selection menu.



[Note]

- Using  and  button to go to the selection and press  button to confirm the selection.
- A commercial Miracast Dongle (Wireless Adapter) is required for the display device.

2 Select **Wireless > Mode > Miracast** to enable Miracast mode.

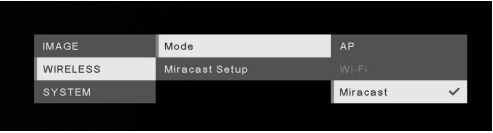

3 Select **Miracast > display device**.

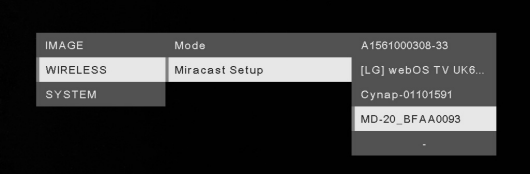

[Note]

- The detected display devices will be list out.
- Press  back to the menu.
- The camera image will display on the display device's screen after connecting.

Using the Camera
Storage the Camera

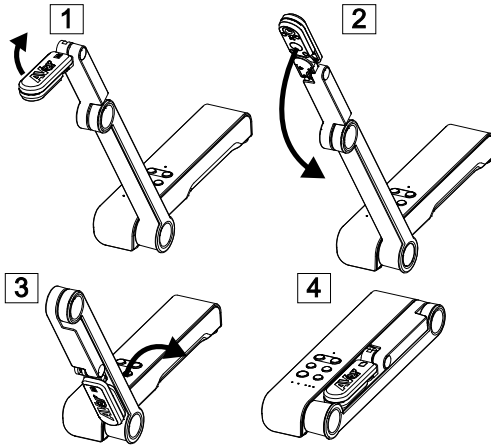

Using the Camera (continue)

Using Angle of the Camera

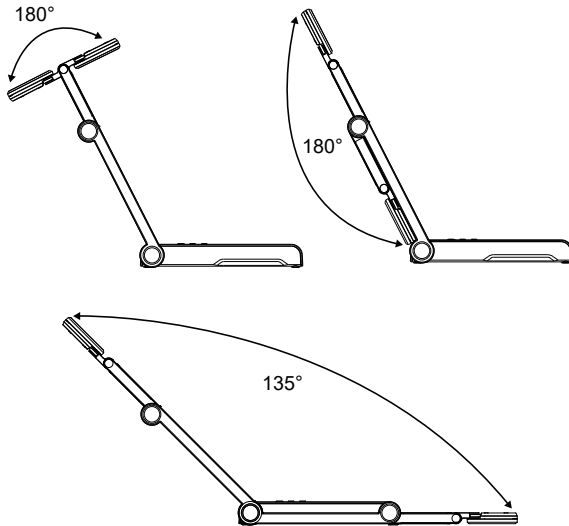

Mounting the Camera on a Flat Surface

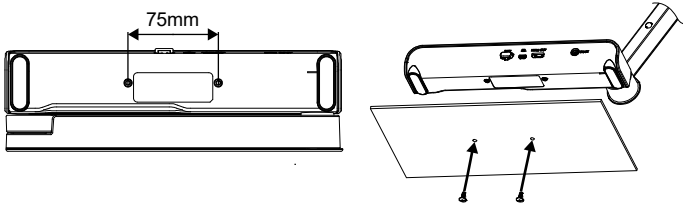

Rotate the Camera Head

Move the camera head as figure shown.

[CAUTION] To avoid damage the camera head, hold the edge of the camera head to rotation the camera head.

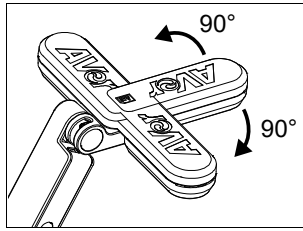

Shooting Area

When camera position is 330mm high, the shooting area will be A3 size.

Place the object as illustrate show, the object image is in positive direction.

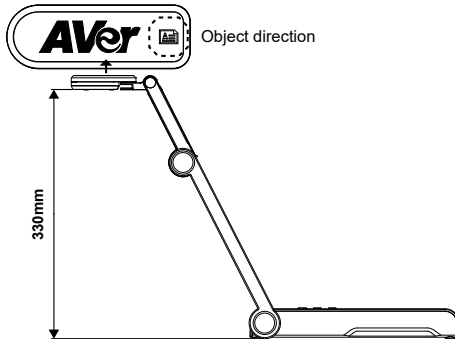
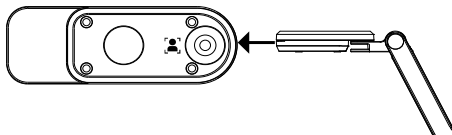

Image Shooting Direction

To shoot people, adjust the camera lens as illustrate shown; the people image is in positive direction.



Specification

Sensor	1/3.06" CMOS
Pixel Count	13 megapixels
Frame Rate	60 fps (max.)
Image mode	Normal / High Frame / High Quality
Effect	Rotate / Freeze
HDMI Output	4K; 1080p 60Hz; 720p 60Hz
Focusing	Auto / Manual/ Area (SW)
Shooting Area	426mm x313mm @ 330 mm
Zooming	Total 23X maximum
Dual Mode	AP / Station DHCP(Server/Client)
WiFi Streaming	1080P@30fps, up to 4K@30fps
Dual Band	5GHz/2.4GHz
Miracast	Yes
Compatibility	802.11a/b/g/n/ac (45 ft effective range)
Wireless Security	SUPPORT WEP, WPA/WPA2-PSK, WPA/WPA2-Enterprise* *EAP-PEAP, EAP-TLS
Power Source	DC5V/ 2A, AC 100-240V
Consumption	4 Watts(lamp on) 3.5 Watts(lamp off)
Lamp Type	LED light
USB	USB2.0 Type-A(WiFi Dongle) USB Type mini-B x 1
DC 5V Input	Power Jack
MIC	Built-in
Operating	518mm(L)*84 mm(W)*351mm(H) (+/-2mm include rubber foot)
Folded	280mm(L)*84mm(W)*42mm(H) (+/-2mm include rubber foot)
Weight	0.68 kg (about 1.5lbs)
Software Supported	ePTZ Image/ Area capture Picture by Picture Timer Cloud library Recording Annotation

NOTE: This equipment has been tested and found to comply with the limits for a Class A digital device, pursuant to part 15 of the FCC Rules. These limits are designed to provide reasonable protection against harmful interference when the equipment is operated in a commercial environment. This equipment generates, uses, and can radiate radiofrequency energy and, if not installed and used in accordance with the instruction manual, may cause harmful interference to radio communications. Operation of this equipment in a residential area is likely to cause harmful interference in which case the user will be required to correct the interference at his own expense.

FCC Caution: Any changes or modifications not expressly approved by the party responsible for compliance could void the user's authority to operate this equipment.

This device complies with part 15 of the FCC Rules.

Operation is subject to the following two conditions:

- (1) This device may not cause harmful interference, and
- (2) this device must accept any interference received, including interference that may cause undesired operation.

CE Class A

Warning:

This is a class A product. In a domestic environment this product may cause radio interference in which case the user may be required to take adequate measures.

NOTICE

SPECIFICATIONS ARE SUBJECT TO CHANGE WITHOUT PRIOR NOTICE. THE INFORMATION CONTAINED HEREIN IS TO BE CONSIDERED FOR REFERENCE ONLY.

COPYRIGHT

©2020 AVer Information Inc. All rights reserved.

TRADEMARKS

"AVer" is a trademark owned by AVer Information Inc. Other trademarks used herein for description purpose only belong to each of their companies.

CAUTION

Risk of Explosion if Battery is replaced by an Incorrect Type. Dispose of Used Batteries According to the Instructions.

DISCLAIMER

No warranty or representation, either expressed or implied, is made with respect to the contents of this documentation, its quality, performance, merchantability, or fitness for a particular purpose. Information presented in this documentation has been carefully checked for reliability; however, no responsibility is assumed for inaccuracies. The information contained in this documentation is subject to change without notice.

In no event will AVer be liable for direct, indirect, special, incidental, or consequential damages arising out of the use or inability to use this product or documentation, even if advised of the possibility of such damages.

WARNING

- Do not drop the camera or subject it to physical shock.
- Use the correct power supply voltage to avoid the damaging camera.
- Do not place the camera where the cord can be stepped on as this may result in fraying or damage to the lead or the plug.
- Do not pull the mechanical arm and camera part in the opposite direction.
- To reduce the risk of fire or electric shock, do not expose this appliance to rain or moisture. Warranty will be void if any unauthorized modifications are done to the product.
- Hold the bottom of the camera with both hands to move the camera. Do not grab the lens or Flexible arm to move the camera.

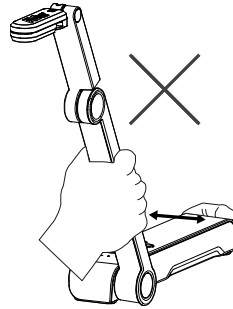
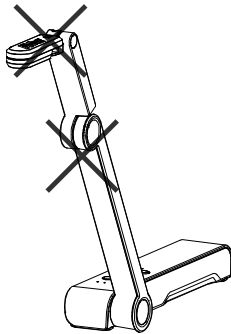

RADIO FREQUENCY

FOR PORTABLE DEVICE USAGE (<20m from body/SAR needed eg. BT dongle, smartphone)

Radiation Exposure Statement:

The product comply with the FCC portable RF exposure limit set forth for an uncontrolled environment and are safe for intended operation as described in this manual. The further RF exposure reduction can be achieved if the product can be kept as far as possible from the user body or set the device to lower output power if such function is available.

FOR MOBILE DEVICE USAGE (>20cm/low power eg. AP routers)

Radiation Exposure Statement:

This equipment complies with FCC radiation exposure limits set forth for an uncontrolled environment. This equipment should be installed and operated with minimum distance 20cm between the radiator & your body.

RADIO FREQUENCY

Europe – EU Declaration of Conformity

This device complies with the essential requirements of the Radio Equipment Directive (2014/53/EU). The following test methods have been applied in order to prove presumption of conformity with the essential requirements of the Radio Equipment Directive (2014/53/EU)



THE MARK OF CROSSED-OUT WHEELED BIN INDICATES THAT THIS PRODUCT MUST NOT BE DISPOSED OF WITH YOUR OTHER HOUSEHOLD WASTE. INSTEAD, YOU NEED TO DISPOSE OF THE WASTE EQUIPMENT BY HANDING IT OVER TO A DESIGNATED COLLECTION POINT FOR THE RECYCLING OF WASTE ELECTRICAL AND ELECTRONIC EQUIPMENT. FOR MORE INFORMATION ABOUT WHERE TO DROP OFF YOUR WASTE EQUIPMENT FOR RECYCLING, PLEASE CONTACT YOUR HOUSEHOLD WASTE DISPOSAL SERVICE OR THE SHOP WHERE YOU PURCHASED THE PRODUCT.

CONTACT INFORMATION

Global

AVer Information Inc.

www.aver.com

8F, No.157, Da-An Rd., Tucheng Dist.,

New Taipei City

Taiwan

European Headquarters

AVer Information Europe B.V.

Westblaak 140, 3012KM, Rotterdam, Netherland

Tel: +31(0)10 7600 550

Technical support: EU.RMA@aver.com

內容包裝物

請確定包裝中附有下列項目的物品。如有缺少的項目，請與你的經銷商連絡。

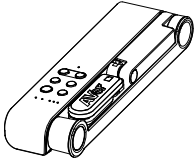

M15W 本機

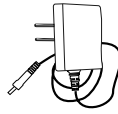

電源變壓器/電源插頭



USB 連接線



保固卡*



安裝指南

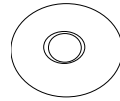

軟體光碟**



無線接收器(選配)

*只有日本、台灣和歐洲使用

**只有日本和歐洲使用

選購配件



手提袋

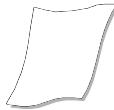

防眩光片

資訊

技術問題、技術支援、軟體和使用指南下載，請連結下面網址：

下載中心: <https://tw.aver.com/download-center>

技術支援: <https://tw.aver.com/technical-support>

硬體介紹

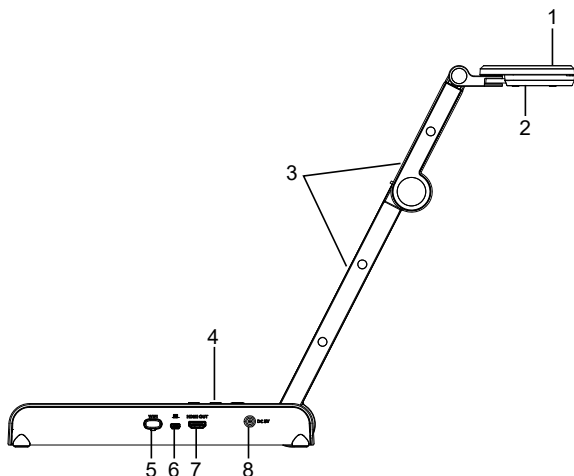

1. 攝影機頭	2. LED 燈
3. 機械臂	4. 控制面板
5. Wi-Fi 接收器	6. USB 埠
7. HDMI 輸出埠	8. DC 電源插孔

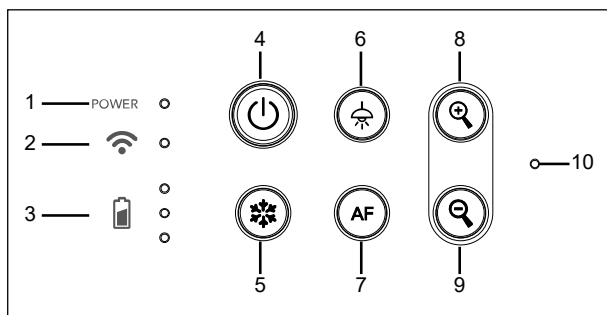

控制面板



- | | |
|-------------------|--------------|
| 1. 電源燈號 | 6. 頂燈(開啟/關閉) |
| 2. Wi-Fi 燈號 | 7. 自動對焦 |
| 3. 電池燈號 | 8. 畫面放大 |
| 4. 電源鈕(啟動/關閉/待機*) | 9. 畫面縮小 |
| 5. 畫面暫停 | 10. 內建麥克風 |

*待機模式只在接上電源時支援。

LED 燈號

<p>電源</p>	<p>綠燈恆亮：電源啟動 熄滅：電源關閉 紅燈恆亮：待機模式* *待機模式只在接上電源時支援。</p>
<p>Wi-Fi </p>	<p>藍燈恆亮：無線分享器模式或 STA 連接 藍燈閃爍：軟體連接機器(M15W)中 藍燈快閃：建立無線分享器模式或 STA 連接中 綠燈恆亮：Miracast 模式 綠燈閃爍：Miracast 傳輸中 綠燈快閃：Miracast 設備掃描或連接中</p>
<p>電池 </p>	<p>綠燈恆亮(x3)：電力 100% ~ 60% 綠燈恆亮(x2)：電力 60% ~ 30% 綠燈恆亮(x1)：電力 30% ~ 5% 紅燈恆亮(x2)：電力 5% ~ 0% 紅燈閃爍(x1)：無電力 橘燈恆亮(x3)：電池異常</p>

[註]

當電池使用很久後會衰竭，請勿自行更換電池。請與你的經銷商連絡。

複合功能鍵

長按 3 秒啟動複合鍵功能



MORE INFO / BATTERY：顯示系統資訊和電池電力狀態。



CAPTURE：可擷取目前畫面影像，透過軟體上傳到雲端或儲存到軟體。

按下複合鍵啟動功能。

FACTORY RESET



+ ：回到出廠預設值。

RESOLUTION：兩鍵一起按可切換下列解析度



- +  - 自動偵測最佳解析度：4K、720P、1080P
- 1024x768 (如果連接的 HDMI 設備有支援)
- 4K 60Hz (如果連接的 HDMI 設備有支援)

MODE



- + ：兩鍵一起按可切換下列模式
- 一般模式：調整影像漸層
- 運動模式：增加訊框率，使用此模式需要充足的光線。
- 高品質模式：更佳影像品質

設備連接

1 插入電源並啟動M15W。

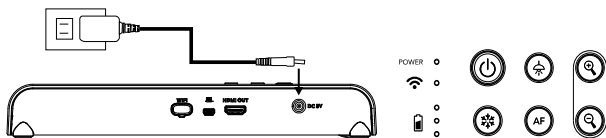

[註]

- 首次使用請完全充電後才使用。
- 當電源啟動後，機器是位於「待機」狀態。在待機狀態，可透過 USB 線與其他可供電設備（如：電腦）充電；但電源需為 5V2V 且充電時間較長。
- 當機器在運作時(非待機狀態)，筆記電腦、投影機或螢幕無法透過 USB 線連接提供電力給機器
- 當連接到牆上的插座充電時，電池燈號顯示為綠燈閃爍。
- 當機器無法操作時，按 **AF** + **Q** 鍵可重啟機器。

2 將 M15W 與筆記型電腦和 HDMI 輸出顯示設備連接。

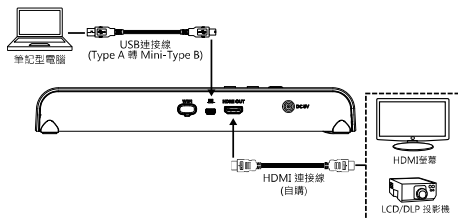



[註]

- 當機器啟動後，無線模式是啟動狀態。
- 當機器透過 USB 線連接到筆記型電腦，無線模式會關閉，切換為 USB 模式，其連接模式會顯示於相連的 HDMI 螢幕上。

透過 Wi-Fi 接收器點對點(P2P)連接(選配)

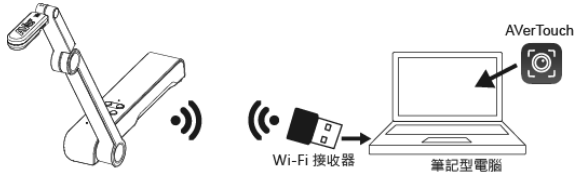
- 1 將 Wi-Fi 接收器安裝到筆記電腦或電腦到，並安裝 AVerTouch 軟體。



- 2 啟動 AVerTouch 軟體，點選  連接實務攝影機。



[註] 可確認位於實務攝影機底部的序號來找尋你的實務攝影機。

- 3 點選下一步繼續。

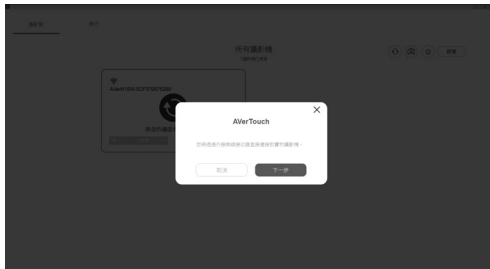

- 4 於攝影機名稱和攝影機密碼(可略過)欄位輸入實務投影機名稱和密碼，然後點選完成繼續。



- 5 連接實務攝影機。



[註] 約需等待 60 秒來完成連接。

- 6 點選 X 可離開即時影像顯示畫面。

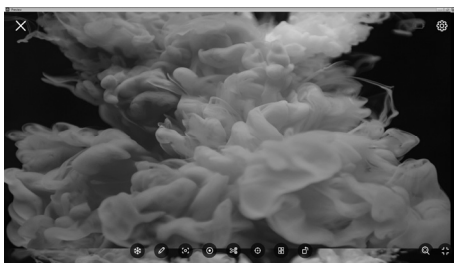

[註] 當連線成功，會看到實務攝影機的即時影像顯示畫面。

Wi-Fi 的連接

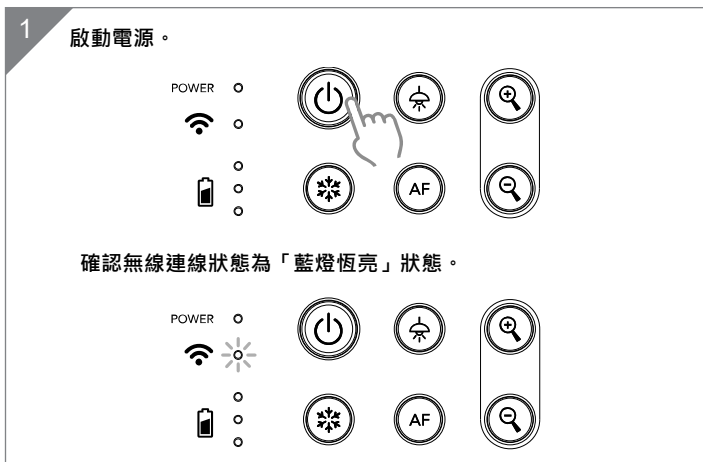

3

選擇  與實物攝影機連接。



4

選擇  切換到實務攝影機即時影像畫面。





Miracast 的連接

1 按  鈕進入選單。



[註]

- 使用  和  鈕往上往下在選單中移動，按  鈕可確認選擇的項目。
- 顯示設備位需要安裝 Miracast 接收器，例如：微軟出的無線接收器。

2 請選擇「無線」>「模式」>「Miracast」來啟動 Miracast 模式。



3 選擇「Miracast 設定」> 顯示設備的名稱。



[註]

- 所有可連接的顯示名稱會列於出。
- 按  回到選單。
- 當連接完成後，機器的影像會顯示於選擇的顯示設備螢幕上。

使用 M15W

收納 M15W

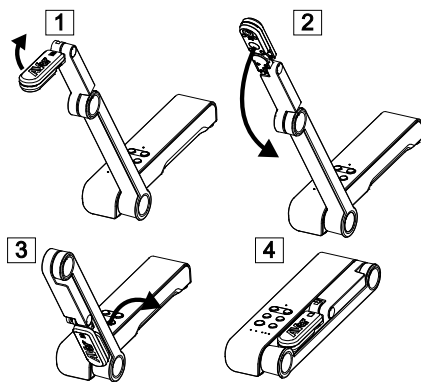

使用 M15W(接續)

可使用角度

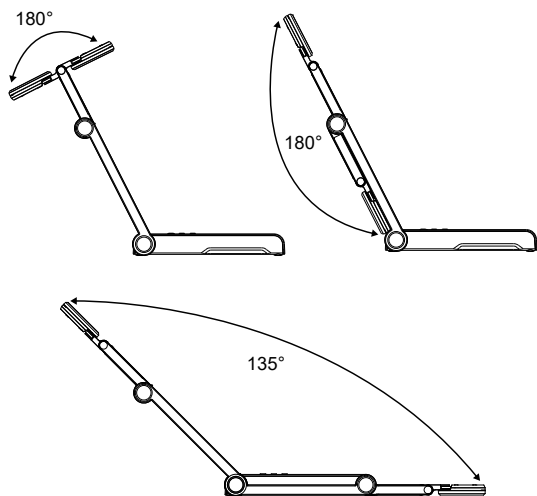

安裝 M15 於平面上

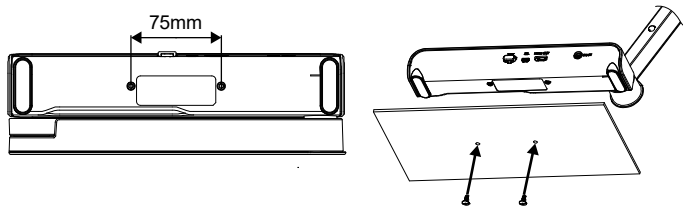

旋轉鏡頭

請照圖中所示旋轉鏡頭，往左 90 度或往右 90 度。

[注意] 未免損傷鏡頭，請將手抓在鏡頭的兩側來旋轉。

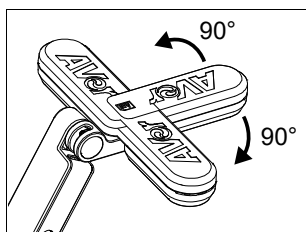

拍攝範圍

當鏡頭高度位於 330mm 時，此拍攝區域可拍攝最大範圍在 A3 尺寸內。照鏡頭上方圖示擺放物體，所投射的出來的影像是正方位。

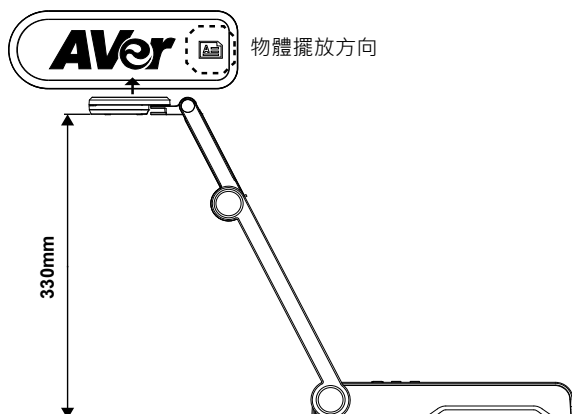

人像拍攝方向

當拍攝人物時，請將鏡頭向外轉面且鏡頭上的人物圖示為正的，人物站於鏡頭前，所拍攝的人物影像會是正方位。

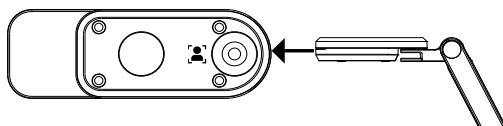

規格

感應器	1/3.06" CMOS	
有效畫素	13 megapixels	
畫格速率	60 fps (最高)	
影像模式	一般/運動/高品質	
效果	旋轉/靜止	
HDMI 輸出	4K; 1080p 60Hz; 720p 60Hz	
對焦	自動/手動/區域(軟體)	
拍攝範圍	426mm x313mm @ 330 mm	
縮放倍數	共 23X	
Dual Mode	AP / Station DHCP(伺服器端/使用者端)	
WiFi 傳輸率	1080P@30fps, up to 4K@30fps	
Dual Band	5GHz/2.4GHz	
Miracast	有	
相容性	802.11a/b/g/n/ac (45 呎有效範圍)	
無線安全協定	支援 WEP, WPA/WPA2-PSK, WPA/WPA2-Enterprise* *EAP-PEAP, EAP-TLS	
電源	DC5V/ 2A, AC 100-240V	
耗電量	4 Watts(開燈) 3.5 Watts(不開燈)	
頂燈	LED 燈	
USB	USB2.0 Type-A(WiFi 接收器) USB Type mini-B x 1	
DC 5V 輸入	電源插孔	
麥克風	內建	
使用時	518mm(L)*84 mm(W)*351mm(H) (+/-2mm 包含像膠底座)	
收起後	280mm(L)*84mm(W)*42mm(H) (+/-2mm 包含像膠底座)	
淨重	0.68kg (約 1.5lbs)	
軟體支援	ePTZ 影像/區域 PBP(畫面並排) 註記功能	計時功能 雲端圖書館 錄影

警告

- 為降低火災或觸電風險，請勿將本產品暴露在雨中或潮濕環境中。如果對產品進行任何未經授權的修改，保固將無效。
- 請勿使機器掉落或受到撞擊。
- 請使用正確的電源電壓以避免損壞機器。
- 請勿將機器放在容易被踩到電源線的地方，否則可能會導致電源線或插頭磨損或損壞。
- 請用雙手握住機器底部以移動機器。請勿抓住鏡頭或機械臂來移動機器。
- 請勿往左右相反方向拉扯機械臂和機器本體。

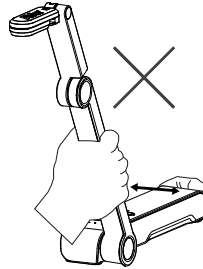
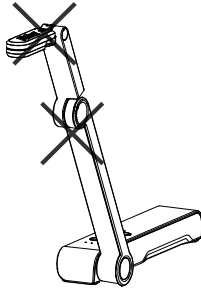

免責聲明

對於產品品質、效能、適銷性或特定用途之適用性，本文件內容皆不代表任何明示或暗示保固或陳述。本文資訊經過仔細詳查，內容可靠無誤；雖然如此，若有任何錯誤，恕不負責。本文所含資訊如有變更，恕不另行通知。

若因使用或不當使用本產品或本文，導致任何直接、間接、特殊、意外或後續損害，即使本公司已事先告知此類損害之可能性，亦不負任何賠償責任。

商標

AVer 為圓展科技股份有限公司之商標。因本內容之描述出現的商標分屬個別公司所有且均受智慧財產權相關法令保護。本文內所有提及之產品或企業名稱僅供識別與說明用途，且為各自擁有者之商標或註冊商標。

著作權

©2020 圓展科技 版權所有

警告使用者

這是甲類的資訊產品，在居住的環境中使用時，可能會造成射頻干擾，在這種情況下，使用者會被要求採取某些適當的對策

連絡資訊

圓展科技股份有限公司
新北市 236 土城區 大安路 157 號 8 樓
電話:(02)2269-8535
<http://tw.aver.com>



若產品上標有打叉記號的滾輪垃圾桶，表示不得將產品與其他家用垃圾一同丟棄。請將廢棄的設備交由指定之廢電機電子設備回收站處理。關於處理廢棄設備之詳細資訊，請洽當地的家庭垃圾處理服務處或您購買產品的商家。

單元Unit	限用物質及其化學符號					
	鉛 Lead (Pb)	汞 Mercury (Hg)	鎘 Cadmium (Cd)	六價鉻 Hexavalent chromium (Cr ⁺⁶)	多溴聯苯 Polybrominated biphenyls (PBB)	多溴二苯醚 Polybrominat ed diphenyl ethers (PBDE)
電路板及零組件 (電子料或電機 料...等)	-	○	○	○	○	○
塑膠組件(外殼或 導電泡棉...等)	○	○	○	○	○	○
金屬組件(鐵殼或 鐵條或螺柱...等)	-	○	○	○	○	○
配件(電源供應器 或遙控器或電纜 線...等)	-	○	○	○	○	○
紙製品及包裝件 (紙盒或手冊或泡 殼...等)	○	○	○	○	○	○
備考 1. “超出 0.1 wt %” 及 “超出 0.01 wt %” 係指限用物質之百分比含量超出百分比含量基準值。 Note 1: “Exceeding 0.1 wt %” and “exceeding 0.01 wt %” indicate that the percentage content of the restricted substance exceeds the reference percentage value of presence condition. 備考 2. “○” 係指該項限用物質之百分比含量未超出百分比含量基準值。 Note 2: “○” indicates that the percentage content of the restricted substance does not exceed the percentage of reference value of presence. 備考 3. “-” 係指該項限用物質為排除項目。 Note 3: The “-” indicates that the restricted substance corresponds to the exemption.						

パッケージ同梱物

本製品には、以下の内容がパッケージに同梱されています。
同梱物に不備がありました場合、お手数ですが本製品をご購入頂きました販売店まで、ご連絡ください。

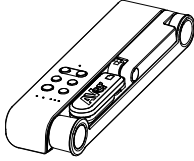

M15W 本体

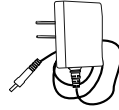

電源アダプタ/電源プラグ

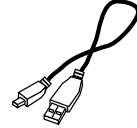

USB ケーブル



保証書*

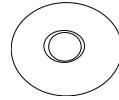

取扱説明書

ソフトウェア
CD**

*日本およびヨーロッパのみ付属

**日本およびヨーロッパのみ付属

オプション(別売り)

キャリーバツ
グ

反射防止シート

お困りの場合

よくある質問、技術サポート、ソフトウェアおよび取扱説明書のダウンロードはこちらから行うことができます。

全世界共通:

<http://presentation.aver.com/download-center/>

日本:

<http://jp.aver.com/download-center>

ハードウェア部位 名称

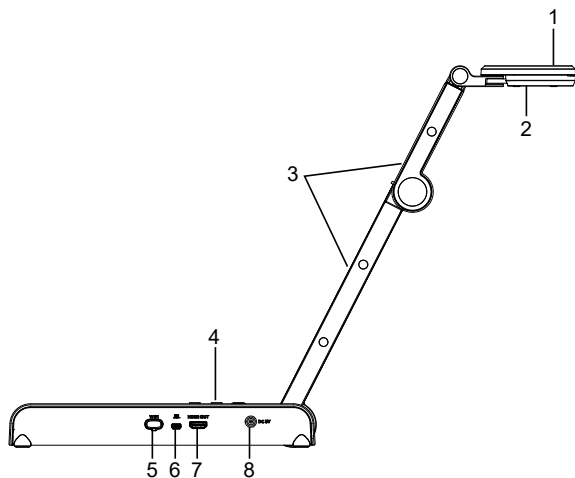

1. カメラヘッド	2. LED ライト
3. アーム	4. 操作パネル
5. Wi-Fi ドンゲル	6. USB ポート
7. HDMI 出力	8. 電源差込口

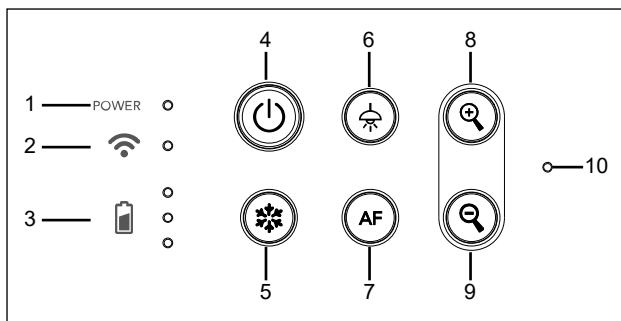

操作パネル



1. 電源 LED インジケータ
2. Wi-Fi LED インジケータ
3. バッテリー状態インジケータ
4. 電源ボタン
(オン/オフ/スタンバイ*)
5. 一時停止
6. LED ライト(オン/オフ)
7. オートフォーカス
8. 拡大
9. 縮小ズームアウト
10. 内蔵マイク

* 電源アダプタ接続時、スタンバイモードに対応しています。

LED インジケータ

	<p>緑点灯：電源オン 点灯なし：電源オフ 赤点灯：スタンバイモード* * 電源アダプタ接続時、スタンバイモードに対応していません。</p>
	<p>青点灯：AP モード待機中 / STA 接続済み 青ゆっくり点滅：ソフトウェアがカメラに接続しています 青点滅：Create AP モード / STA 接続中 緑点灯：Miracast モード待機中 緑ゆっくり点滅：Miracast ストリーミング開始 緑点滅：Miracast デバイスがスキャン 接続中</p>
	<p>緑点灯(3本)：バッテリー満充電 (100% ~ 60%) 緑点灯(2本)：バッテリー残量 60% ~ 30% 緑点灯(1本)：バッテリー残量 30% ~ 5% 赤点灯(1本)：バッテリー残量 5% ~ 0% 赤で点滅(1本)：バッテリー残量 なし オレンジ色点灯(3本)：バッテリー異常</p>

【ご注意】

バッテリーは長期間使用すると消耗します。お客様自身でのバッテリー交換は故障の原因となりますのでご注意ください。

ショートカットキー

3秒間押し続けます



メニュー：システムとバッテリーの状態を表示します。



キャプチャー：現在の画面を静止画撮影します。
 (撮影時、ソフトウェアまたはクラウドに保存されます。)

複合ボタンを押して機能を有効にします。

リセット



工場出荷時の設定状態に戻します。

解像度切替



ボタンを押す度に、下記順番で切り替わります。

-解像度自動検出 (4K, 720p, 1080p)

-1024x768 (※HDMI 出力先対応時)

-4K 60Hz (※HDMI 出力先対応時)

モード選択



ボタンを押す度に、下記順番で切り替わります。

-ノーマル：通常モード

-モーション：動きのある被写体向け。フレーム数が増加しますが、明るい場所でご利用ください。

-高画質：映像画質を向上させます。

デバイス接続

1

製品付属の電源アダプタを接続し、M15Wの電源を入れます。

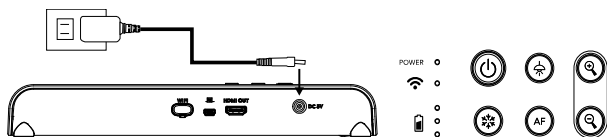

【注意】

- 初回使用前に必ずバッテリーを完全に充電してください。
- カメラの電源プラグを挿しこむと、カメラは「スタンバイ」モードの状態です。スタンバイモードでは、他のデバイスから USB 接続で充電することができますが、充電時間が長くなります。
- カメラの動作中は、ノートパソコン、プロジェクタ、またはモニターから USB 接続を介してカメラのバッテリーを充電することはできません。
- カメラをコンセントから充電しているときは、バッテリーインジケータが緑色に点滅しています。
- カメラが正常に作動しない場合、**AF** + **Q** を押してください。

2

M15W と、パソコンや HDMI 搭載表示装置などを接続します。

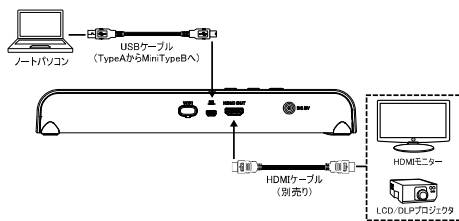

【注意】

- カメラの電源を入れると、Wi-Fi モードがオンになります。
- USB ケーブルを使用し、ノートパソコンと接続時、Wi-Fi モードは無効になります。HDMI デバイスの取扱説明書に従ってください。

Wi-Fi 接続

1

カメラの電源を入れます。



Wi-Fi のランプが青く点灯していることを確認します。



2

AVerTouch を起動し、画面の指示内容に従いカメラの Wi-Fi 機能を有効にします。



【注意】

- ソフトウェアがネットワーク上のカメラを自動検出します。
- 接続するカメラを選択してください。
- カメラ名は「AVerCam WiFi ドングルの MAC アドレス」になります。Mac アドレスはカメラによって異なります。

3

 を選択してカメラに接続してください。



4

 を選択してライブスクリーンのスイッチを入れてください。

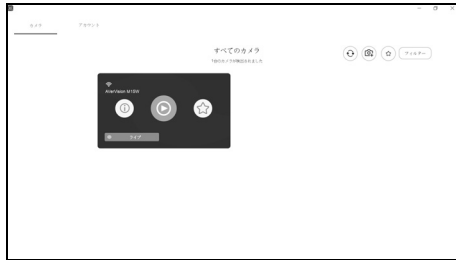



ミラキャスト接続

1

 を押してメニュー画面に入ってください。



【注意】

-  および  ボタンで選択を行い、 ボタンを押して選択を確定してください。
- ディスプレイデバイスは Microsoft (ワイヤレスアダプタ) 製など市販のミラキャストdongルをインストールする必要があります。

2

「無線接続」 > 「モード」 > 「ミラキャスト」の順番で選択してミラキャストを有効にしてください。

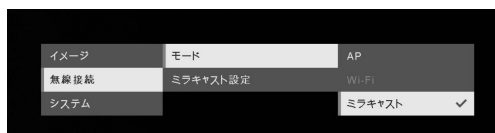

3

「ミラキャスト設定」 > ディスプレイデバイスを選択してください。

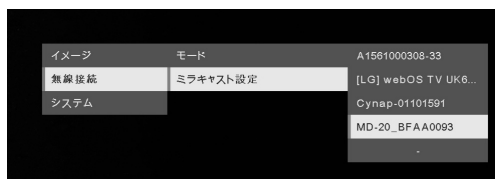

【注意】

- ディスプレイデバイスのリストが表示されます
- 次に、 ボタンを押してメニューに戻り。
- 完了後、カメラの画像がディスプレイデバイスの画面に表示されます。

カメラを使用

カメラの保管方法

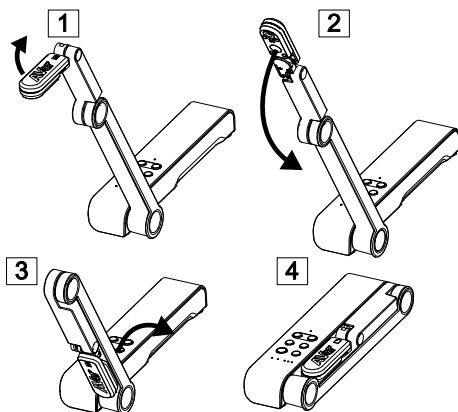

カメラを使用する(続き)

カメラの角度調節

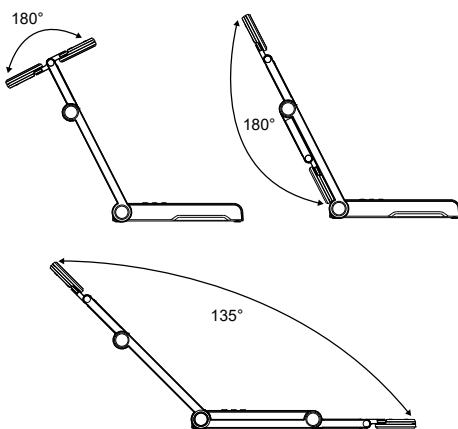

カメラのねじ固定を行う箇所・寸法

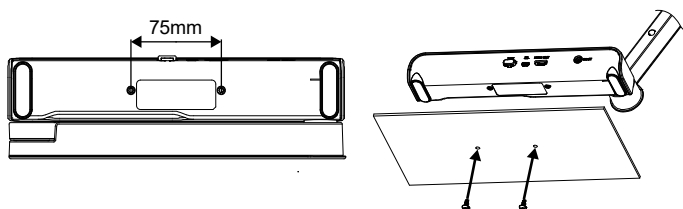

カメラを使用する(続き)

カメラヘッドの回転

図のようにカメラヘッドを動かします。

【ご注意】 破損防止のため、カメラヘッドの端を持ちながらカメラヘッドを回転させてください。

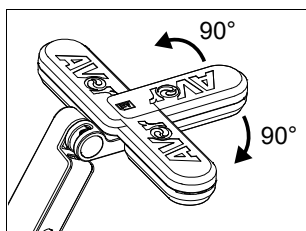

撮影範囲

カメラ位置が高さ 330mm の場合、撮影範囲は A3 サイズです。

カメラヘッドのロゴと同じ向きに被写体が撮影されます。

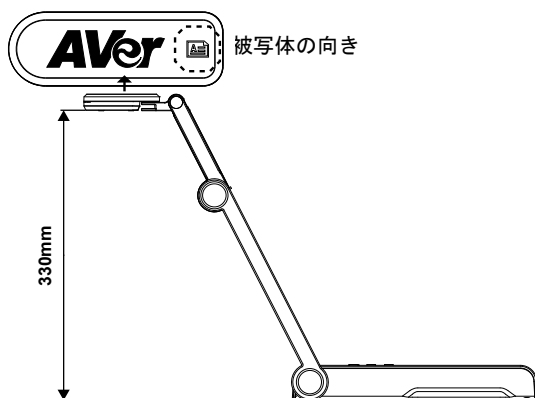

写真の撮影方向

人物を撮影するには、下図のようにカメラの向きを調整します。

人物マークの頭が上の状態が正しい向きになります。

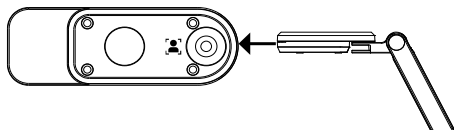

仕様

センサー	1/3.06" CMOS	
ピクセル数	13メガピクセル	
フレームレート	60 FPS (最大)	
動画画質	ノーマル / 高フレーム / 高画質	
機能	回転機能 / 一時停止	
HDMI 出力	4K: 1080p 60Hz; 720p 60Hz	
フォーカス	オート / マニュアル/ エリア (ソフトウェア)	
撮影範囲	426mm×313mm @ 330 mm	
ズーム	最大 23 倍	
デュアルモード	AP / Station DHCP(サーバー/クライアント)	
WiFi ストリーミング	1080P@30FPS、最大 4K@30FPS まで	
デュアルバンド	5GHz/2.4GHz	
Miracast	対応	
互換性	802.11a/b/g/n/ac (有効範囲約 13 メートル)	
ワイヤレスセキュリティ	SUPPORT WEP, WPA/WPA2-PSK, WPA/WPA2-Enterprise* *EAP-PEAP, EAP-TLS	
電源	DC5V/ 2A, AC 100-240V	
消費電力	4 W(LED ライト点灯時) 3.5 W(LED ライト消灯時)	
ライト種類	LED ライト	
USB	USB2.0 Type-A(WiFi ドングル) USB Type mini-B × 1	
DC 5V 入力	電源アダプタ給電方式	
MIC	本体内蔵	
寸法 (使用時)	518mm(長さ)×84 mm(幅)×351mm(高さ) (+/-2mm のゴム脚含む)	
寸法 (折りたたみ時)	280mm(長さ)×84mm(幅)×42mm(高さ) (+/-2mm のゴム脚含む)	
重量	0.68kg(1.5lbs)	
基本機能	ePTZ 画像/エリアキャプチャ ピクチャーバイピクチャー タイマー	クラウドライブラリ保存 記録 アノテーション (書き込み機能)

告知

仕様は事前の通知なしに変更されることがあります。
ここに含まれる情報は参考としてご利用ください。

著作権

©2020 AVer Information Inc. 本書の著作権を保有します。

商標

「AVer」は、AVer Information Inc. が所有する商標です。ここで記載されている目的で使用されているその他の商標は、同社にのみ属しています。

注意

本製品のバッテリーは、**お客様**自身では交換できない仕様になっており、**バッテリー交換**は別途有償となります。バッテリーの交換をご依頼いただく場合、製品をご購入いただきました販売代理店までご連絡ください。適合外のバッテリーへ交換を行った場合、破損の危険があります。指示に従って使用済み電池を処分してください。

VCCI-A

この装置は、クラス A 機器です。この装置を住宅環境で使用すると電波妨害を引き起こすことがあります。

この場合には使用者が適切な対策を講ずるよう要求されることがあります。

警告

- 火災や感電の危険防止のため、本機を雨や湿気にさらさないでください。製品に不正な改造が加えられている場合、製品保証は無効となります。
- カメラを落としたり、衝撃を与えないでください。
- 落下により生じた破損の場合、保証は無効となります。
- カメラ破損防止のため、正しい電圧の電源を使用してください。
- コードを踏む可能性がある場所にカメラを置かないでください。ケーブルやブラ
- グが破損する恐れがあります。
- メカニカルアームとカメラ部を反対方向に引く張らないでください。
- カメラの下部を両手で持ちながら、カメラを動かしてください。レンズやアームを持ってカメラを動かさないでください。

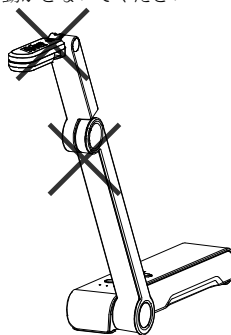
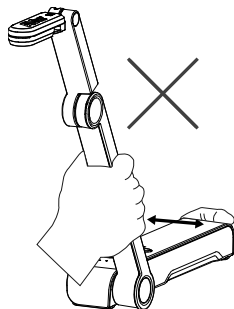

製品の仕様・ご利用方法に関するお問い合わせ
お客様相談窓口 TEL：0120-008-382

Inhalt Der Verpackung

Die folgenden Artikel sind Bestandteile dieses Produktes. Falls ein Teil fehlen sollte, wenden Sie sich bitte an den Händler, bei dem Sie dieses Produkt erworben haben.

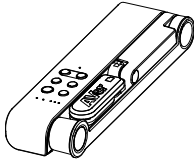

M15W-Gerät

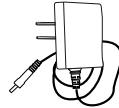

Netzadapter/Netzstecker

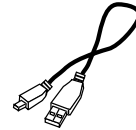

USB-Kabel



Garantiekarte*



Bedienungsanleitung

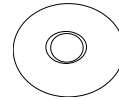

Software-CD**



WLAN-Dongle(Optional)

*Nur für Japan, Taiwan und Europa

**Nur für Japan und Europa

Optionales Zubehör



Tragetasche



Blendschutz

Mehr Hilfe

Für FAQs, technische Unterstützung, Software und für den Download der Bedienungsanleitung besuchen Sie bitte:

Global:

<http://presentation.aver.com/download-center/>

Technischer Support:

<https://de.aveurope.com/technical-support>

Hardware-Teile

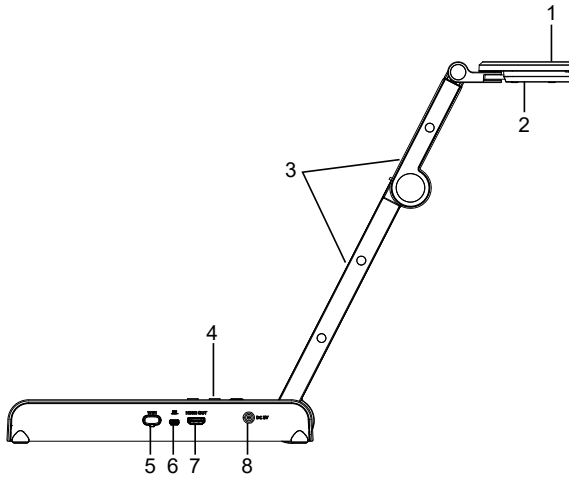

1. Kamerakopf	2. LED-Leuchte
3. Arm	4. Bedienfeld
5. WLAN-Dongle	6. USB-Anschluss
7. HDMI-Ausgang	8. DC-Buchse

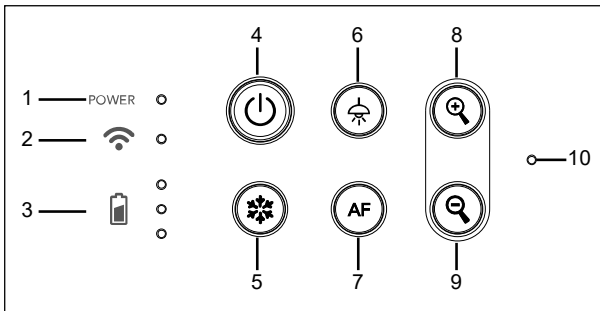

Bedienfeld



- | | |
|---|--------------------------|
| 1. Stromanzeige | 6. Lampe (Ein/Aus) |
| 2. WLAN-Anzeige | 7. Auto-Fokus |
| 3. Akkuanzeige | 8. Zoom in |
| 4. Ein-/Ausschalter
(Ein/Aus/Standby*) | 9. Zoom out |
| 5. Anhalten | 10. Eingebautes Mikrofon |

* Nach dem Einstecken wird der Standby-Modus unterstützt.

LED-Leuchte

Leistung	Statisch Grün: Strom ein Kein Licht: Ausgeschaltet Statisch Rot: Standby-Modus* * Nach dem Einstecken wird der Standby-Modus unterstützt.
WLAN 	Statisch Blau: AP Modus Bereit/STA verbunden Langsames blaues Blinken: Software-Verbindung mit Kamera Kurzes blaues Blinken: AP-Modus erzeugen/STA-Verbindungsherstellung Statisch Grün: Miracast-Modus bereit Langsames grünes Blinken: Start Miracast-Streaming Schnelles grünes Blinken: Miracast-Gerät Scannen/Verbindung
Akku 	Statisch Grün (x3): Akku voll (100% ~ 60%) Statisch Grün (x2): Akku 60% ~ 30% Statisch Grün (x1): Akku 30% ~ 5% Statisch Rot: (x1): Akku 5% ~ 0% Blinkt Rot: (x1): Akku leer Statisch Orange (x3): Akku Störung

[Hinweis]

Akku nach Langzeitnutzung erschöpft. Tauschen Sie den Akku nicht selbst aus. Wenden Sie sich an Ihren Händler.

Verbundtaste

Gedrückt halten(3 sekunden)



MORE INFO / BATTERY : Display Systeminformationen und Akkustatus.



CAPTURE : Schnappschuss des aktuellen Bildschirms für die Software oder die Cloud.

Drücken Sie die Tasten, um die Funktion der Verbundtasten zu aktivieren.

FACTORY RESET



+ : Zurück zu Werkseinstellungen

RESOLUTION





Für die Umschaltung zwischen den folgenden Modi drücken:

- Autom. Erkennung der besten Auflösung (4k, 720P, 1080P)
- 1024x768 (bei HDMI-Geräteunterstützung)
- 4K 60 Hz (bei HDMI-Geräteunterstützung)

Verbundtaste (forts.)

Drücken Sie die Tasten, um die Funktion der Verbundtasten zu aktivieren.

- MODE
-  +  Für die Umschaltung zwischen den folgenden Modi drücken:
- Normal: Bildgradient anpassen
 - Bewegung: Framerate erhöhen. In diesem Modus muss die Beleuchtung ausreichend sein.
 - Hohe Qualität, bessere Bildqualität



Geräteanschluss

1

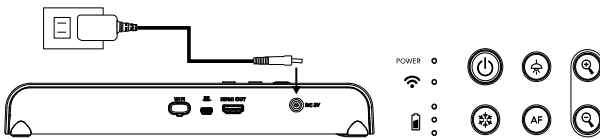
Netzadapter einstecken und M15W einschalten.



[Hinweis]

- Bitte laden Sie die Kamera vor der ersten Verwendung vollständig auf.
- Sobald die Kamera eingeschaltet ist, ist sie im „Standby“-Modus. Im Standby-Modus kann sie über die USB-Verbindung mit dem anderen Gerät aufgeladen werden, allerdings wird ein 5V-/2A-Netzteil benötigt und die Ladezeit verlängert sich.
- Ein Laptop, Projektor oder Monitor kann die Stromversorgung der Kamera während des Kamerabetriebs **nicht** bereitstellen.
- Wenn die Kamera über eine Steckdose aufgeladen wird, leuchtet die Akkuanzeige grün.
-  +  drücken, um die Kamera bei einer Störung neu zu starten.

2

Verbinden von M15W mit einem Laptop und HDMI-Display

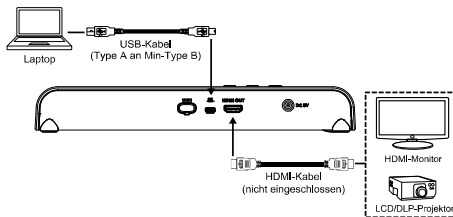

[Hinweis]

- Sobald die Kamera eingeschaltet wird, wird der WLAN-Modus aktiviert.
- Wenn die Kamera über den USB-Anschluss mit einem Laptop verbunden wird, wird der WLAN-Modus deaktiviert. Beachten Sie bitte die Richtung am HDMI-Gerät.

P2P- Verbindung über WLAN-Dongle(Optional)

- 1 WLAN-Dongle am PC/Laptop einstecken und AVerTouch-App installieren.

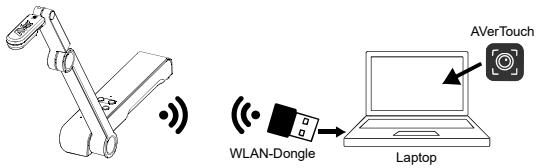

- 2 AVerTouch-App öffnen und zum Verbinden der Kamera anklicken 



[Hinweis] Prüfen Sie die Seriennummer unten an der Kamera, um die Kamera zu ermitteln.

- 3 Klicken Sie zum Fortfahren auf "Weiter".

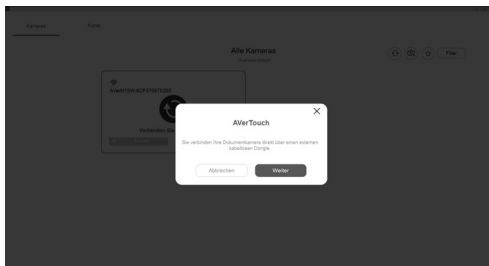

4

Klicken Sie nach der Eingabe von Kameraname und Passcode auf “Done” (Fertig), um fortzufahren.

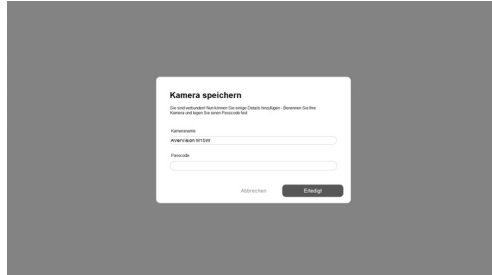

5

Klicken Sie auf die Schaltfläche “Done” (Fertig), um die Kamera zu verbinden.



[Hinweis] Es dauert ungefähr 60 Sekunden, um die Verbindung herzustellen.

6

Über “X” verlassen Sie die Live-Ansicht-Seite.



[Hinweis] Bei erfolgreicher Verbindung sehen Sie die Live-Ansicht der Kamera.

WLAN-Einrichtung

1 Schalten Sie die Kamera ein.

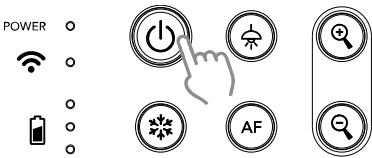

Das Diagramm zeigt eine Reihe von Symbolelementen: 'POWER' mit einem Power-Symbol, ein WLAN-Symbol, ein Batteriesymbol, ein Schneeflockensymbol, ein 'AF' (Autofokus) Symbol und ein Suchglas-Symbol. Ein Handzeiger zeigt auf das Power-Symbol.

Überprüfen Sie den WLAN-Status - Blaue Leuchte ein.

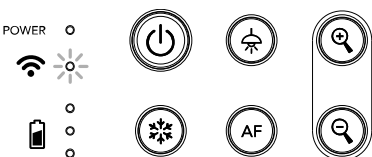

Das Diagramm zeigt dieselben Symbolelemente wie oben, aber das WLAN-Symbol ist nun mit einem blauen Lichteffekt versehen, was den eingeschalteten WLAN-Status anzeigt.

2 Öffnen Sie AVerTouch und befolgen Sie die Bildschirmanweisungen, um die WLAN-Funktion der Kamera zu aktivieren.

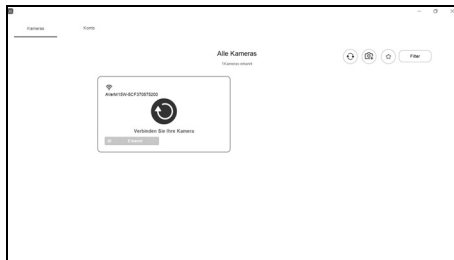

[Hinweis]

- Die Software erkennt die Kamera in Ihrem Netzwerk automatisch.
- Wählen Sie die Kamera aus, mit der Sie sich verbinden möchten.
- Der Kameraname lautet „AVerCam WiFi dongle *mac address*“
Die Mac-Adresse weicht abhängig von der Kamera ab.

3

Wählen Sie , um die Verbindung mit der Kamera herzustellen.

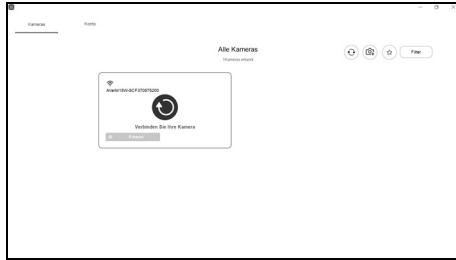

4

Wählen Sie , um zum Live-Bildschirm der Kamera umzuschalten.

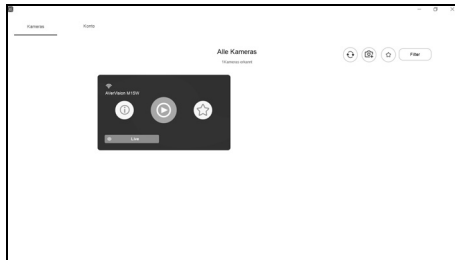



Miracast-Verbindung

1

Drücken Sie , um auf das Auswahlnenü zuzugreifen.



[Hinweis]

- Mit  und der -Taste gehen Sie zur Auswahl und drücken die -Taste, um Ihre Auswahl zu bestätigen.
- A commercial Miracast Dongle (Wireless Adapter) is required for the display device.

2

Wählen Sie bitte Wireless" > "Modus" > "Miracast", um den Miracast-Modus zu aktivieren.

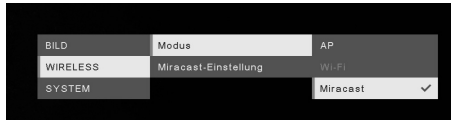

3

Wählen Sie „Miracast-Einstellung“ > Anzeigerät



[Hinweis]

- Die Anzeigeräte werden angezeigt.
- Drücken Sie  um zum Menü zurückzukehren.
- Dann wird das Kameragerät auf dem Bildschirm des Anzeigerätes angezeigt.

So Verwenden Sie Die Kamera
Aufbewahrung Der Kamera

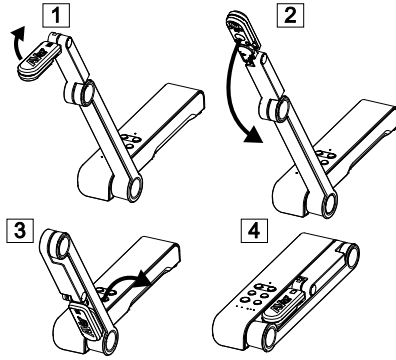

Verwendung des Kamerawinkels

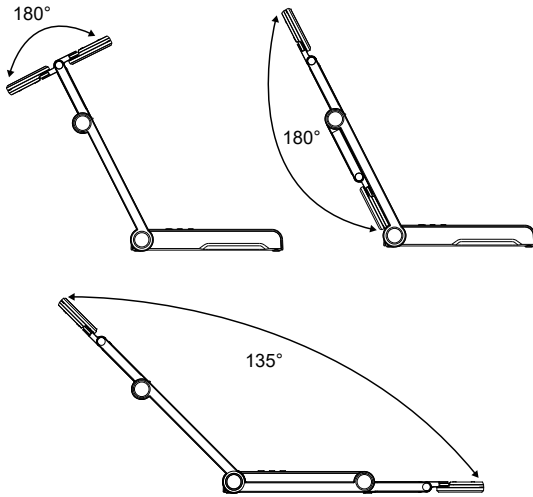

Kameramontage auf einer flachen Oberfläche

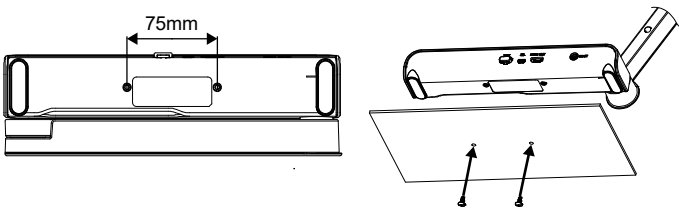

Kamerakopf drehen

Kamerakopf wie in der Abbildung bewegen

[VORSICHT] Zur Vermeidung von Schäden am Kamerakopf halten Sie den Kamerakopf an der Kante fest, wenn Sie den Kamerakopf drehen möchten.

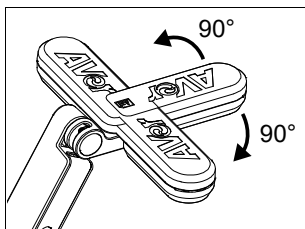

Aufnahmebereich

Wenn die Kameraposition eine Höhe von 330mm hat, ist der Aufnahmebereich A3-Größe. Platzieren Sie den Gegenstand wie in der Abbildung gezeigt. Das Objektbild ist in positiver Richtung.

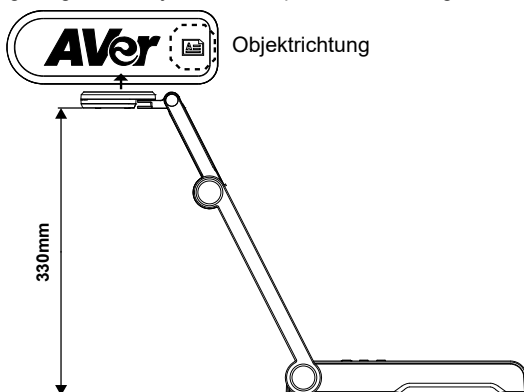

Bildaufnahmerichtung

Für die Aufnahme von Personen passen Sie das Kameraobjektiv wie abgebildet an. Das Bild der Personen ist in positiver Richtung.

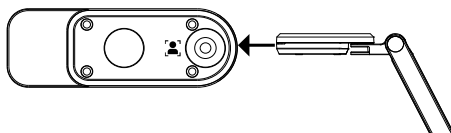

Technische Daten

Sensor	1/3.06" CMOS
Pixel	13 Megapixel
Bildrate	60 fps (max.)
Bildmodus	Normal/High Frame/Hohe Qualität
Effekt	Drehen/Anhalten
HDMI-Ausgang	4K; 1080p 60Hz; 720p 60Hz
Fokussierung	Autom./Manuell/Bereich (SW)
Aufnahmebereich	426 mm x313 mm @ 330 mm
Zoom	Gesamt 23-fach max.
Dual-Modus	AP / Station DHCP (Server/Client)
WLAN-Streaming	1080P@30fps, bis zu 4K@30fps
Dualband	5 GHz/2,4 GHz
Miracast	Ja
Kompatibilität	802.11a/b/g/n/ac (45 Fuß effektiver Bereich)
WLAN-Sicherheit	UNTERSTÜTZUNG VON: WEP, WPA/WPA2-PSK, WPA/WPA2-Enterprise* *EAP-PEAP, EAP-TLS
Stromquelle	DC5V/ 2A, AC 100-240V
Stromverbrauch	4 Watt (Lampe ein) 3,5 Watt (Lampe aus)
Lampentyp	LED-Leuchte
USB	USB2.0 Type-A (WLAN-Dongle) USB Type mini-B x 1
DC 5V Eingang	Strombuchse
MIC	Eingebaut
Betrieb	518 mm (L)*84 mm (B)*351 mm (H) (+/-2 mm, einschließlich Gummifuß)
Gefaltet	280 mm(L)*84 mm(B)*42 mm (H) (+/-2 mm, einschließlich Gummifuß)
Gewicht	0.68 kg(1.5 lbs)
Software-Unterstützung	ePTZ Bild/Bereichserfassung Bild-für-Bild Timer Cloud-Bibliothek Aufnahme Kommentieren

HINWEIS

DIE TECHNISCHEN DATEN UNTERLIEGEN ÄNDERUNGEN OHNE VORANKÜNDIGUNG. DIE ANGABEN IN DIESER UNTERLAGE DIENEN NUR ZUR INFORMATION.

COPYRIGHT

© 2020 AVer Information Inc. Alle Rechte vorbehalten.

WARENZEICHEN

„AVer“ ist ein Warenzeichen von AVer Information Inc. Andere in diesem Dokument genannten Warenzeichen dienen lediglich der Information und sind Eigentum der entsprechenden Unternehmen.

VORSICHT

Explosionsgefahr, wenn nicht der richtige Batterietyp verwendet wird. Entsorgen Sie gebrauchte Batterien entsprechend den Vorschriften.

WARNUNG

- Zur Vermeidung der Brandgefahr bzw. von Elektroschocks setzen Sie das Gerät weder Regen noch Feuchtigkeit aus. Die Gewährleistung verfällt, wenn am Produkt unautorisierte Änderungen vorgenommen werden.
- Die Kamera keinen Schlägen oder starker Vibration aussetzen.
- Die richtige Stromspannung wählen, um Schäden an der Kamera zu vermeiden.
- Die Kamera muss so aufgestellt werden, dass niemand auf das Kabel treten kann, weil das Kabel eventuell ausfranst und die Drähte oder der Stecker beschädigt werden können.
- Um die Kamera zu bewegen, halten Sie sie mit beiden Händen an der Unterseite fest. Die Kamera nicht mithilfe von Objektiv oder flexiblem Arm bewegen.
- Den mechanischen Arm und das Kamerateil nicht in die entgegengesetzte Richtung ziehen.

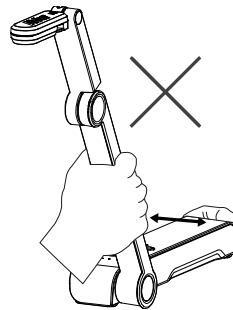
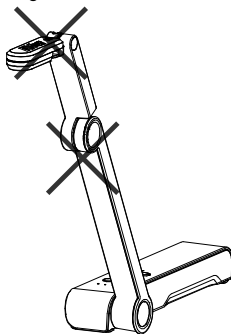

Contenu de L'emballage

Les éléments ci-dessous sont fournis avec ce produit. Si un élément venait à manquer, adressez-vous au revendeur auquel vous avez acheté le produit.

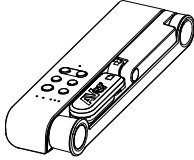

Appareil M15W

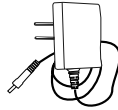

Adaptateur secteur /
Prise d'alimentation



Câble USB



Carte de garantie*



Mode d'emploi

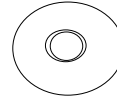

CD du logiciel**



Dongle Wi-Fi
(en option)

*Japon, Taiwan et Europe seulement

*Japan et Europe seulement

Accessoires En Option



Sacoche de
transport



Film antireflet

Aide Supplémentaire

Pour la FAQ, l'assistance technique et le téléchargement du logiciel et du mode d'emploi, rendez-vous sur le site :

International :

<http://presentation.aver.com/download-center/>

Support Technique :

<https://fr.averyeurope.com/technical-support>

Descriptif Materiel

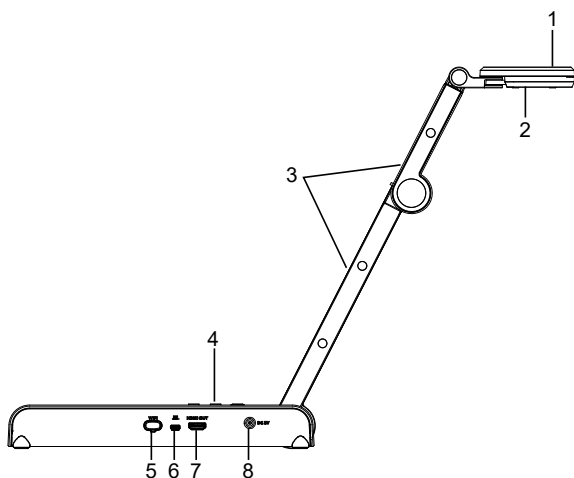

1. Tête caméra	2. Lampe LED
3. Bras	4. Panneau de commandes
5. Dongle WiFi	6. Port USB
7. Sortie HDMI	8. Port secteur CC (jack)

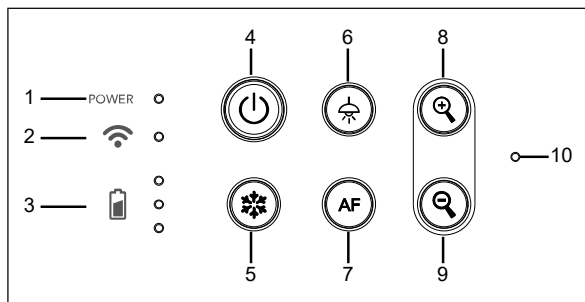

Panneau de Commandes



- | | |
|--|----------------------|
| 1. Voyant d'alimentation | 6. Lampe (on) / off) |
| 2. Voyant WiFi | 7. Auto-focus |
| 3. Voyant batterie | 8. Zoom avant |
| 4. Bouton marche/arrêt
(Marche / arrêt / veille*) | 9. Zoom arrière |
| 5. Gel | 10. Micro intégré |

* Le mode veille est pris en charge tant que l'appareil est branché sur le secteur.

Voyant LED

Alimentation	<p>Vert fixe : marche Éteint : arrêt Rouge fixe : veille*</p> <p>* Le mode veille est pris en charge tant que l'appareil est branché sur le secteur.</p>
WiFi 	<p>Bleu fixe : Mode PA prêt / STA connecté Bleu, clignotement lent : connexion du logiciel à la caméra en cours Bleu, clignotement rapide : créer mode PA / Connexion STA en cours Vert fixe : mode Miracast prêt Vert, clignotement lent : démarrage diffusion Miracast Vert, clignotement rapide : recherche d'appareil Miracast / connexion en cours</p>
Batterie 	<p>Vert fixe (x3) : la batterie est chargée (entre 60 et 100 %) Vert fixe (x2) : la charge de la batterie se trouve entre 30 et 60 % Vert fixe (x1) : la charge de la batterie se trouve entre 5 et 30 % Rouge fixe (x1) : la charge de la batterie se trouve entre 0 et 5 % Rouge clignotant (x1) : la batterie est déchargée Orange fixe (x3) : La batterie ne fonctionne pas normalement</p>

[Remarque]

À long terme, les performances de la batterie baissent. Ne remplacez-pas vous-même la batterie. Veuillez vous adresser à votre revendeur.

Clé Composite

Appuyer Longuement(3 secondes)



MORE INFO / BATTERY : Affichage des informations système et du statut de charge de la batterie.



CAPTURE : Envoi d'une capture de l'image en direct vers le logiciel ou le Cloud

Appuyez sur les touches pour utiliser la fonction touche composée.

FACTORY RESET



+



: Retour aux paramètres usine

RESOLUTION



+



: Appuyer pour commuter entre les modes suivants :

- Détection automatique de la meilleure resolution (4k, 720p, 1080p)

- 1024x768 (si pris en charge par l'équipement HDMI)

- 4K 60Hz((si pris en charge par l'équipement HDMI)

MODE



+



: Appuyer pour commuter entre les modes suivants

-Normal : régler le gradient de l'image.

-Mouvement : augmenter la cadence. Ce mode exige un éclairage suffisant.

-Haute qualité : meilleure qualité d'image.

Connexion d'appareils

1

Branchez l'adaptateur secteur et allumez M15W.

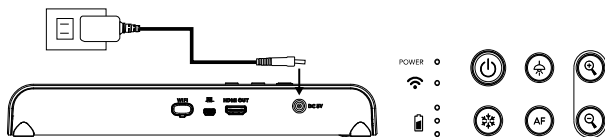

[Remarque]

- Chargez la batterie à fond avant la première utilisation.
- Lorsque vous allumez la caméra, elle se met en mode **Veille**. En mode veille, la batterie peut être chargée depuis le port USB d'un autre appareil, mais l'alimentation nécessaire est de 5V-2A, et le temps de chargement sera plus long
- Vous ne pouvez pas alimenter la caméra par le biais du port USB d'un ordinateur, d'un projecteur ou d'un moniteur quand elle est en cours d'utilisation.
- Si la caméra est en cours de chargement depuis une prise secteur, le voyant de batterie clignote en vert.
- Appuyez sur **AF** + **Q** pour redémarrer si la caméra ne fonctionne pas correctement.

2

Connectez M15W à un ordinateur portable et à un écran HDMI.

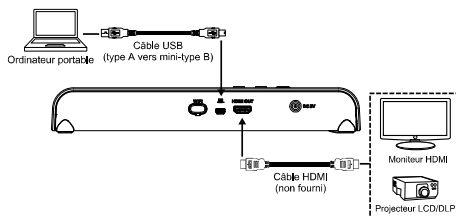

[Remarque]

- Le mode WiFi s'active lorsque vous allumez la caméra.
- Si vous connectez la caméra à un ordinateur portable par un port USB, le mode WiFi se désactive. Suivez les instructions qui s'affichent sur l'appareil HDMI.

Connexion pair-à-pair (P2P) par dongle WiFi (en option)

- 1 **Branchez le dongle Wi-Fi sur PC / ordinateur portable et installez l'application AVerTouch.**

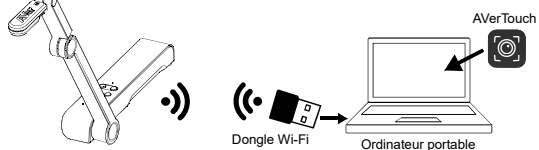

- 2 **Ouvrez l'application AVerTouch, cliquez sur  pour connecter la caméra.**

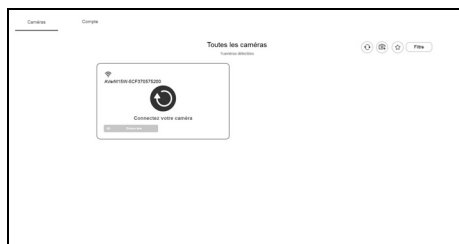

[Remarque] Vérifiez le numéro de série en bas de la caméra pour trouver votre caméra.

- 3 **Cliquez sur Next pour continuer.**

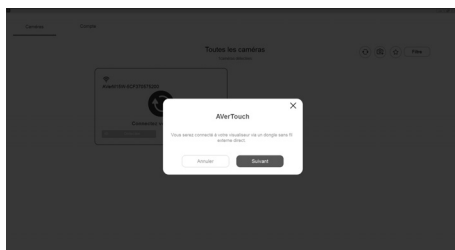

4

Saisie du nom de la caméra et du mot de passe, cliquez sur **Fait** pour continuer.

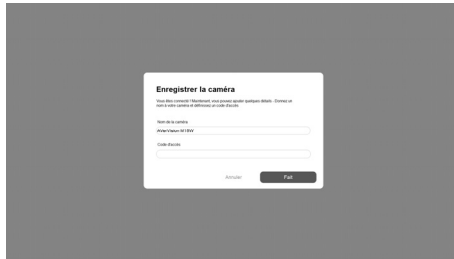
A screenshot of a web form titled "Enregistrer la caméra". The form contains the following fields: "Nom de la caméra" (Camera name), "Mot de passe" (Password), and "Confirmer le mot de passe" (Confirm password). Below the fields are "Annuler" (Cancel) and "Fait" (Done) buttons. The form is centered on a dark gray background.

5

Cliquez sur le bouton **Fait** pour connecter la caméra.



[Remarque] Il faut environ 60 secondes pour réaliser la connexion.

6

Sélectionnez **X** pour quitter la page d'affichage en direct.



[Remarque] Lorsque la connexion est réussie, vous devriez voir la vue en direct de la caméra.

Connexion Wi-Fi

1 Allumez la caméra.

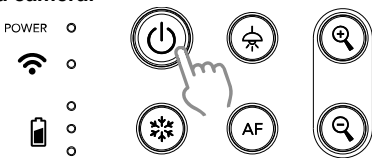

POWER ○
○
○
○
○

○
○
○
○

○
○
○
○

○
○
○
○

Vérifiez le statut du Wifi – Le voyant bleu doit être allumé.

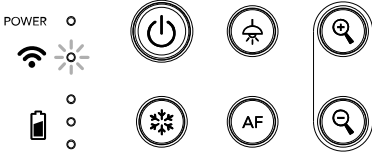

POWER ○
○
○
○
○

○
○
○
○

○
○
○
○

○
○
○
○

2 Ouvrez AVerTouch et suivez les instructions à l'écran pour activer la fonction Wi-Fi de la caméra.



[Remarque]

- Le logiciel détectera automatiquement la caméra sur votre réseau.
- Sélectionnez la caméra que vous souhaitez connecter.
- Le nom de la caméra sera « AVerCam WiFi dongle *adresse Mac* » L'adresse Mac sera différente selon la caméra.

3

Sélectionnez  pour établir la connexion avec la caméra.

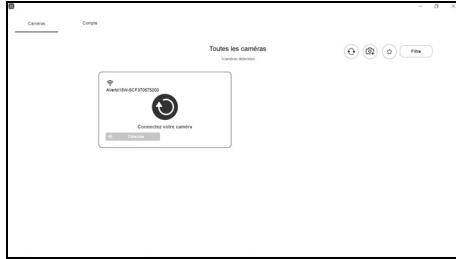

4

Sélectionnez  pour passer à l'écran d'affichage en direct de la caméra.

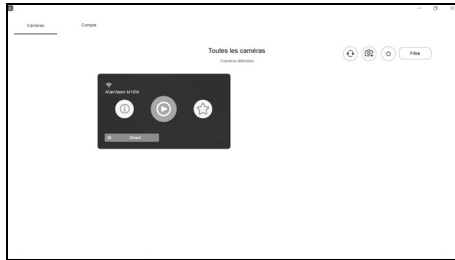



Connexion Miracast

1

Appuyez sur  pour accéder au menu de sélection.



[Remarque]

- À l'aide de  et du bouton , allez à la sélection et appuyez sur le bouton  pour confirmer.
- Un dongle Miracast, comme par exemple la clé Miracast Microsoft, doit être installé sur le système d'affichage.

2

Sélectionnez « Wireless » > « Mode » > « Miracast » pour activer le mode Miracast.



3

Sélectionnez « Miracast » > afficheur



[Remarque]

- il y aura une liste des afficheurs.
- Appuyez sur  pour revenir au menu.
- L'image que capte la caméra s'affichera alors sur l'écran d'affichage.

Utilisation De La Caméra

Rangement de la caméra

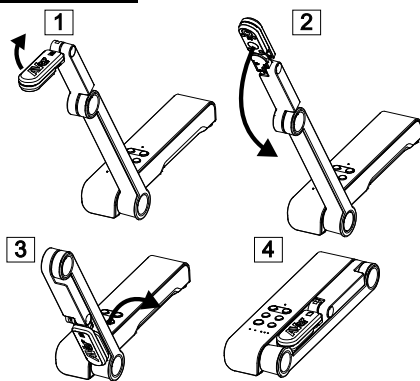

Utilisation de l'angle de la caméra

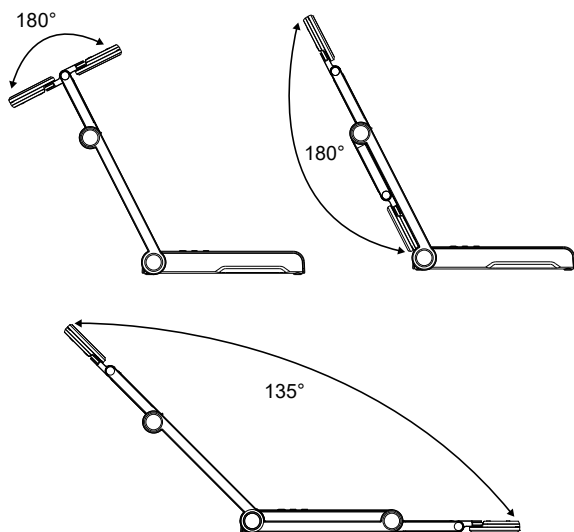

Installation de la caméra sur une surface plane

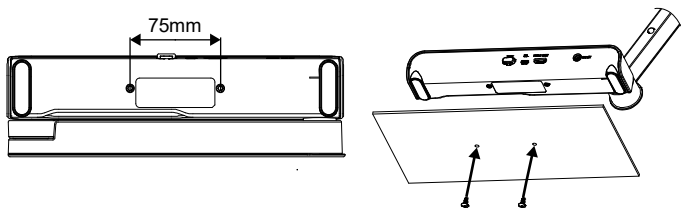

Utilisation De La Caméra (suite)

Rotation de la tête caméra

Déplacez la tête caméra comme illustré.

[ATTENTION] Pour éviter d'endommager la tête caméra, faites-la pivoter en la tenant par le bord.

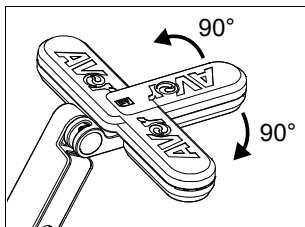

Champ de vision

Si la caméra est à une hauteur de 330 mm, le champ couvre une feuille A3. Placez l'objet comme illustré, afin que son image apparaisse en position normale.

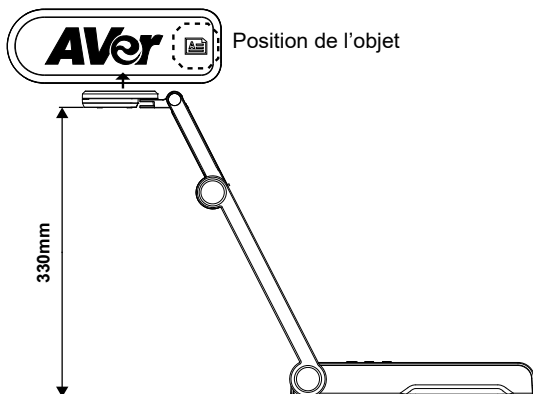

Cadrage de personnes

Pour obtenir une image de personnes en position normale, orientez l'objectif comme illustré.

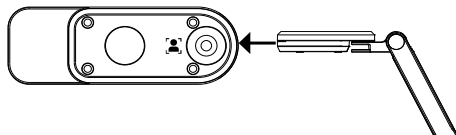

Caractéristiques

Capteur	CMOS de 1/3,06 pouce	
Nombre de pixels	13 mégapixels	
Cadence	60 i/s (max.)	
Mode d'image	Normal / Cadence élevée / Haute qualité	
Effet	Rotation / Gel	
Sortie HDMI	4K ; intégrale 1080p 60 Hz ; 720p 60 Hz	
Mise au point	Automatique / Manuelle / Zone (logicielle)	
Champ de vision	426 x 313 mm à 330 mm de distance	
Zoom	x23 maximum	
Mode double	PA / Station DHCP (serveur/client)	
Diffusion WiFi	1080p à 30 i/s, jusqu'à 4K à 30 i/s	
Double bande	5 GHz / 2,4 GHz	
Miracast	Oui	
Compatibilité	802.11a/b/g/n/ac (portée effective 13,7 m)	
Sécurité sans fil	Supporte WEP, WPA/WPA2-PSK, WPA/WPA2-Enterprise* *EAP-PEAP, EAP-TLS	
Alimentation	CC 5 V / 2 A, CA 100-240 V	
Consommation	4 watts (lampe allumée) 3,5 watts (lampe éteinte)	
Type de lampe	Lampe LED	
USB	USB 2.0 Type-A (dongle WiFi) USB Type mini-B x 1	
Entrée CC 5 V	Jack d'alimentation	
Micro	Intégré	
En fonctionnement	518 mm (L) x 84 mm (ℓ) x 351 mm (H) (±2 mm, pied caoutchouc compris)	
Replié	280 mm (L) x 84 mm (ℓ) x 42 mm (H) (±2 mm, pied caoutchouc compris)	
Poids	0,68 kg (1,5 lbs)	
Logiciel pris en charge	ePTZ (balayage horizontal/vertical et zoom électroniques) Capture image / zone	Image par image Minuterie Bibliothèque cloud Enregistrement Annotation

REMARQUES

LES CARACTÉRISTIQUES SONT SUSCEPTIBLES DE MODIFICATIONS SANS AVIS PRÉALABLE. LES INFORMATIONS CONTENUES DANS LE PRÉSENT DOCUMENT DOIVENT ÊTRE CONSIDÉRÉES COMME N'AYANT QU'UNE VALEUR DE RÉFÉRENCE.

COPYRIGHT

©2020 AVer Information Inc. Tous droits réservés.

MARQUES COMMERCIALES

« AVer » est une marque commerciale propriété d'AVer Information Inc. Les autres marques commerciales mentionnées dans ce document à seule fin descriptive appartiennent à leurs sociétés respectives.

ATTENTION

Risque d'explosion si la batterie est remplacée par une autre de type incorrect. La mise au rebut des batteries usagées doit se faire selon les instructions.

AVERTISSEMENT

- Ne laissez pas tomber l'appareil ni ne lui faites subir de heurts.
- Pour éviter d'endommager l'appareil, utilisez la tension d'alimentation correcte.
- Ne placez pas l'appareil de manière à ce que l'on puisse marcher sur le cordon d'alimentation, car cela pourrait provoquer son effilochage ou endommager la prise.
- Ne tirez pas sur le bras mécanique et sur l'appareil dans des directions opposées.
- Pour réduire les risques d'incendie ou de décharges électriques, n'exposez pas cet appareil à la pluie ni à l'humidité. Toute modification non autorisée du produit annulera la garantie.
- Pour déplacer l'appareil, tenez-le par le dessous avec les deux mains. Ne déplacez pas l'appareil en le tenant par l'objectif ou par le bras souple.

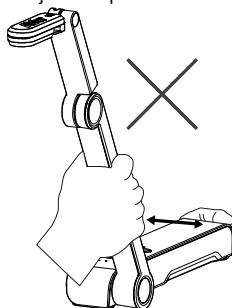
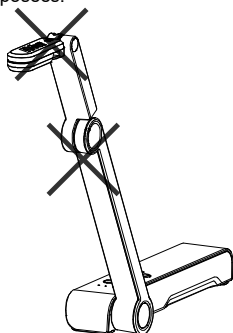

Contenido Del Paquete

Este producto incluye los elementos siguientes. Si falta algún elemento, póngase en contacto con el distribuidor al que adquirió el producto.

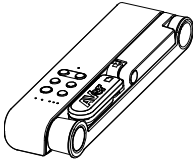

Unidad M15W

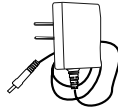

Adaptador de corriente/Enchufe



Cable USB



Tarjeta de garantía*



Manual de instrucciones

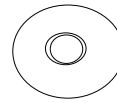

CD de software**



Llave Wi-Fi
(opcional)

*Solo para Japón y Europa

**Solo para Europa

Accesorios Opcionales



Bolsa de transporte



Lámina antirreflectante

Ayuda Adicional

Para preguntas frecuentes, soporte técnico y descargas de software y manuales de instrucciones, visite:

Global:

<http://presentation.aver.com/download-center/>

Soporte técnico:

<https://es.avereurope.com/technical-support>

Componentes

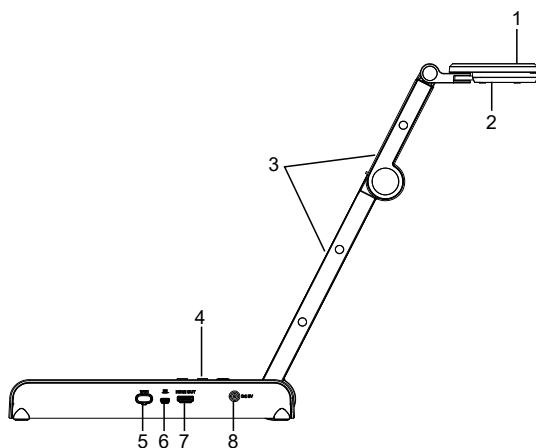

1. Cabezal de la cámara	2. Luz LED
3. Brazo	4. Panel de control
5. Llave Wi-Fi	6. Puerto USB
7. Salida HDMI	8. Conector de alimentación de CC

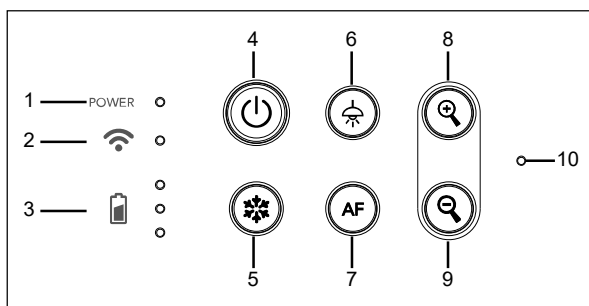

Panel De Control



- | | |
|---|--------------------------------|
| 1. Indicador de alimentación | 5. Congelar |
| 2. Indicador de Wi-Fi | 6. Lámpara (encendida/apagada) |
| 3. Indicador de batería | 7. Enfoque automático |
| 4. Botón de alimentación
(encendido/apagado/en
espera*) | 8. Acercar |
| | 9. Alejar |
| | 10. Micrófono integrado |

* El modo en espera está disponible cuando el dispositivo está enchufado.

Indicador Led

Alimentación	Verde fijo: encendido Ninguna luz: apagado Rojo fijo: modo de espera* * El modo en espera está disponible cuando el dispositivo está enchufado.
Wi-Fi 	Azul fijo: modo AP listo / STA conectado Azul intermitente lento: conexión de software con la cámara Azul intermitente corto: crear modo AP / conectando STA Verde fijo: modo Miracast listo Verde intermitente lento: inicio de transmisión Miracast Verde intermitente rápido: búsqueda de dispositivo Miracast / conectando
Batería 	Verde fijo (x3): batería cargada (100% ~ 60%) Verde fijo (x2): 60% ~ 30% de batería Verde fijo (x1): 30% ~ 5% de batería Rojo fijo (x1): 5% ~ 0% de batería Rojo intermitente (x1): sin batería Naranja fijo (x3): batería anómala

[Nota]

La batería se agotará definitivamente después de un uso prolongado. No intente sustituir la batería. Póngase en contacto con su distribuidor.

Botones

Mantener pulsado(3 segundos)



MORE INFO / BATTERY : Muestra información del sistema y el estado de la batería.



CAPTURE : Realiza una captura de pantalla de la imagen en la pantalla en el software o la nube.

Presione las teclas para operar la función de tecla compuesta.

FACTORY RESET



: Restaura la configuración predeterminada de fábrica.

RESOLUTION



: Pulsar para alternar entre los siguientes modos:
 - Auto detecta la mejor resolución (4K, 720p, 1080p)
 - 1024x768 (si compatibilidad con dispositivo HDMI)
 - 4K 60Hz (si compatibilidad con dispositivo HDMI)

Botones (continuación)

Presione las teclas para operar la función de tecla compuesta.

- MODE : Pulsar para alternar entre los siguientes modos:
- Normal: ajusta el gradiente de imagen.
 - Movimiento: aumenta la velocidad de fotogramas. Este modo requiere una iluminación suficiente.
 - Alta calidad: mayor calidad de imagen.

Conexión del dispositivo

1

Conecte el adaptador de corriente y encienda el M15W.

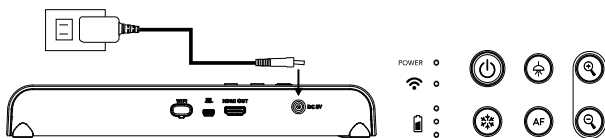

[Nota]

- **Cargue la cámara completamente antes de utilizarla por primera vez.**
- Cuando la cámara está encendida, está en modo «**En espera**». En el modo de espera, se puede cargar a través de una conexión USB desde otro dispositivo; pero se requiere una fuente de alimentación de 5V y 2A, y el tiempo de carga es superior.
- El ordenador portátil, el proyector o el monitor no pueden proporcionar suficiente energía a la cámara a través de la conexión USB mientras la cámara está en funcionamiento.
- Cuando se cargue la cámara a través de la toma de corriente, el indicador de batería parpadeará en verde.
- Pulse **AF** + **Zoom** para reiniciar cuando la cámara no funcione correctamente.

2

Conecte el M15W a un ordenador portátil y a una pantalla HDMI.

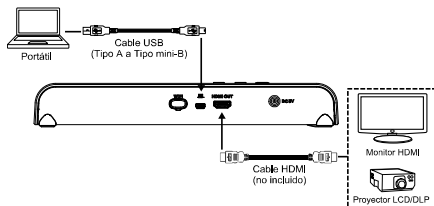

[Nota]

- El modo Wi-Fi está activado cuando la cámara está encendida.
- Cuando la cámara se conecta al ordenador portátil a través del puerto USB, el modo Wi-Fi se desactiva. Siga las indicaciones en el dispositivo HDMI.

Conexión P2P con llave Wi-Fi (opcional)

- 1 Conecte la llave Wi-Fi a un PC/portátil e instale la aplicación AVerTouch.

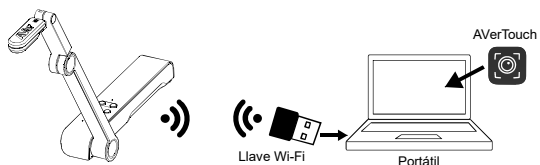

- 2 Abra la aplicación AVerTouch y haga clic en  para conectar la cámara.



[Nota] Compruebe el número de serie en la parte inferior de la cámara para detectar la cámara.

- 3 Haga clic en **Siguiente** para continuar.

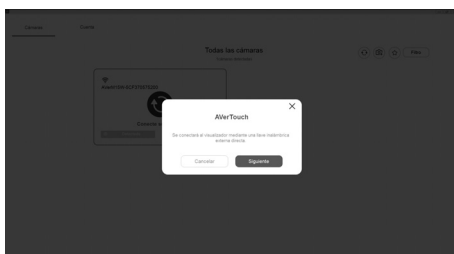

4

Introduzca el nombre de la cámara y el código de acceso y haga clic en Listo para continuar.

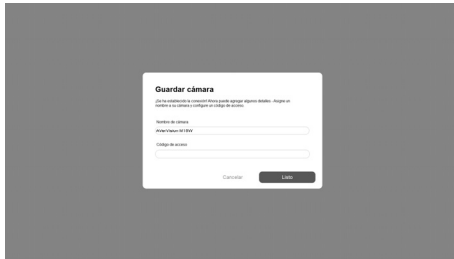

5

Haga clic en el botón Listo para conectar la cámara.



[Nota] La conexión tardará unos 60 segundos en establecerse.

6

Seleccione X para salir de la página de la vista en vivo.



[Nota] Una vez establecida la conexión, se mostrará la vista en vivo de la cámara.

Conexión Wi-Fi

1

Encienda la cámara.



Compruebe el estado de la Wi-Fi (indicador azul encendido).



2

Abra AVerTouch y siga las instrucciones en la pantalla para habilitar la función Wi-Fi en la cámara.

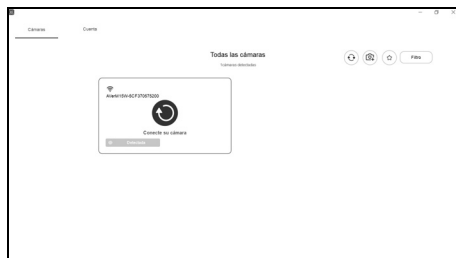

[Nota]

- El software detectará automáticamente la cámara en su red.
- Seleccione la cámara que desee conectar.
- El nombre de la cámara será «AverCam WiFi dongle *dirección mac*» (la dirección MAC variará de una cámara a otra).

3

Seleccione  para establecer una conexión con la cámara.

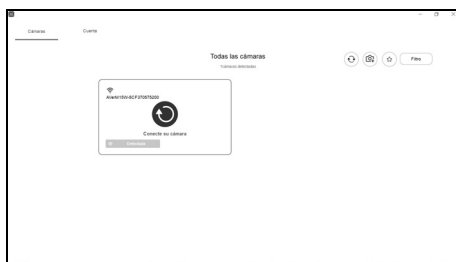

4

Seleccione  para cambiar a la pantalla en vivo de la cámara.

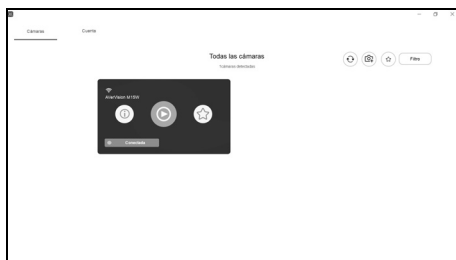



Conexión Miracast

1

Pulse  para acceder al menú de opciones.



[Nota]

- Utilice los botones  y  para ir a la opción y pulse el botón  para confirmar la selección.
- El dispositivo de pantalla requiere la instalación de una llave Miracast comercial, como la de Microsoft (adaptador inalámbrico).

2

(Inalámbrico > Modo > Miracast) para activar el modo Miracast

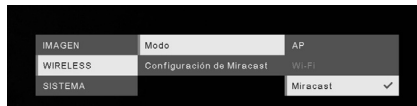

3

Seleccione "Configuración de Miracast" > dispositivo de pantalla.



[Nota]

- Se mostrarán los dispositivos de pantalla
- Pulse  para retroceder en el menú
- La imagen de la cámara se proyectará en la pantalla del dispositivo de pantalla.

Uso De La Cámara

Almacenamiento De La Cámara

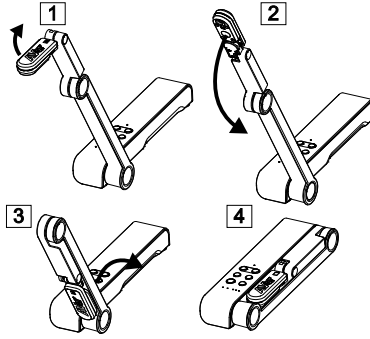

Ángulo De La Cámara

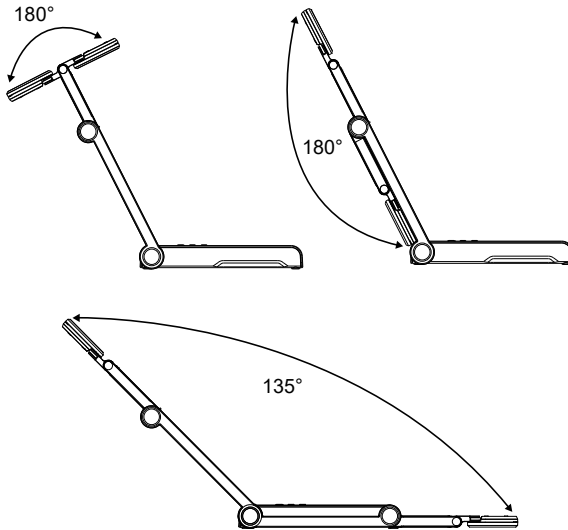

Montaje de la cámara en una superficie plana

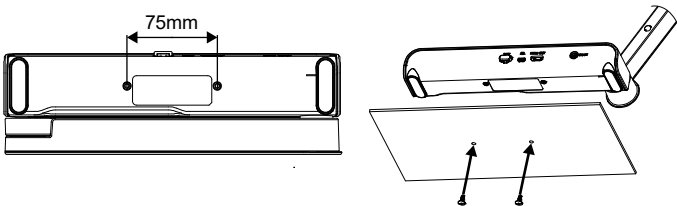

Rotación del cabezal de la cámara

Mueva el cabezal de la cámara como se indica en la figura.

[PRECAUCIÓN] Para no dañar el cabezal de la cámara, sujete el extremo del cabezal de la cámara para girar el cabezal de la cámara.

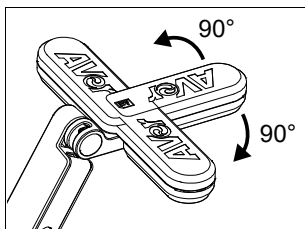

Área de disparo

Cuando la cámara se encuentra a una altura de 330 mm, el área de disparo se corresponde a un tamaño A3. Coloque el objeto como se muestra en la figura; la imagen del objeto está en dirección positiva (no invertida).



Dirección de disparo

Para grabar a personas, ajuste la lente de la cámara como se muestra en la figura; la imagen de las personas está en dirección positiva (no invertida).

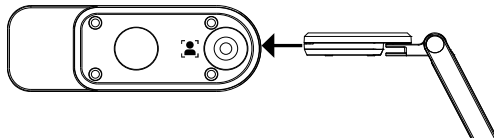

Especificaciones

Sensor	1/3.06" CMOS	
Número de píxeles	13 megapíxeles	
Velocidad de fotogramas	60 fps (máx.)	
Modo de imagen	Normal / Alta velocidad / Alta calidad	
Efecto	Girar / Congelar	
Salida HDMI	4K; 1080p 60Hz; 720p 60Hz	
Enfoque	Auto / Manual / Área (SW)	
Área de disparo	426 mm x313 mm a 330 mm	
Zoom	Total, 23X máx.	
Modo dual	AP / Estación DHCP (servidor/cliente)	
Transmisión Wi-Fi	1080p a 30fps, hasta 4K a 30fps	
Banda dual	5 GHz / 2,4 GHz	
Miracast	Sí	
Compatibilidad	802.11a/b/g/n/ac (alcance efectivo aprox. 14 m [45 pies])	
Seguridad inalámbrica	COMPATIBLE CON WEP, WPA/WPA2-PSK, WPA/WPA2-Enterprise* *EAP-PEAP, EAP-TLS	
Fuente de alimentación	5 VCC/ 2A, 100-240 VCA	
Consumo	4 vatios (lámpara encendida) 3,5 vatios (lámpara apagada)	
Tipo de lámpara	Luz LED	
USB	USB 2.0 tipo A (llave Wi-Fi) USB tipo mini-B x 1	
Entrada de 5 VCC	Conector de alimentación	
Micrófono	Integrado	
En uso	518 mm (largo) x 84 mm (ancho) x 351 mm (alto) (+/-2 mm con los pies de goma)	
Plegada	280 mm (largo) x 84 mm (ancho) x 42 mm (alto) (+/- 2 mm con los pies de goma)	
Peso	0,68 kg (aprox. 1,5 libras)	
Software compatible	ePTZ Imagen / Área de captura Imagen por imagen	Temporizador Biblioteca en la nube Grabación Anotación

AVISO

LAS ESPECIFICACIONES ESTÁN SUJETAS A CAMBIO SIN PREVIO AVISO. LA INFORMACIÓN CONTENIDA EN EL PRESENTE DOCUMENTO SE OFRECE EXCLUSIVAMENTE A TÍTULO DE REFERENCIA.

COPYRIGHT

©2020 AVer Information Inc. Todos los derechos reservados.

MARCAS COMERCIALES

«AVer» es una marca comercial propiedad de AVer Information Inc. Otras marcas comerciales utilizadas en este documento con fines descriptivos pertenecen exclusivamente a sus empresas correspondientes.

PRECAUCIÓN

Existe riesgo de explosión si la batería se sustituye por un tipo de batería incorrecto. Deseche las baterías usadas de acuerdo con las instrucciones.

ADVERTENCIA

- No deje caer la cámara ni la someta a golpes.
- Utilice la tensión de alimentación adecuada para no dañar la cámara.
- No coloque la cámara en un sitio donde el cable pueda ser pisado; de lo contrario, el cable o el enchufe podrían deteriorarse o sufrir daños.
- Sostenga la parte inferior de la cámara con ambas manos para mover la cámara. No toque la lente ni el brazo flexible para mover la cámara.
- Para reducir el riesgo de incendio o descarga eléctrica, no exponga el dispositivo a la lluvia o la humedad. En caso de realizarse modificaciones no autorizadas en el producto, se invalidará la garantía.
- No tire del brazo mecánico y la cámara en sentido contrario.

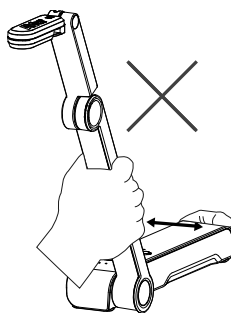
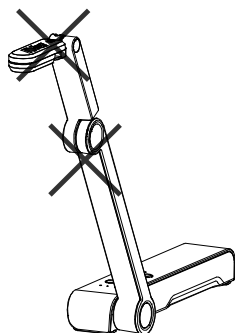

Contenuto della confezione

I seguenti articoli vengono forniti in dotazione con questo prodotto. Qualora vi siano articoli mancanti, contattare il rivenditore presso il quale è stato acquistato il prodotto.

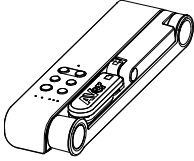

Unità M15W

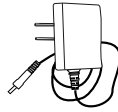

Adattatore di corrente /
Presa di corrente

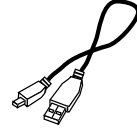

Cavo USB



Scheda di garanzia*



Manuale d'istruzioni

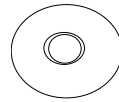

CD software**



Dongle Wi-Fi
(Opzionale)

*Solo per Giappone, Taiwan, ed Europa

**Solo per Giappone ed Europa

Accessori opzionali



Borsa di
trasporto



Foglio
anti-riflesso

Altro Aiuto

Per Domande tecniche, assistenza tecnica, download di software e manuale di istruzioni, invitiamo a visitare:

A livello mondiale:

<http://presentation.aver.com/download-center/>

Assistenza tecnica:

<https://aver.com/technical-support>

Componenti hardware

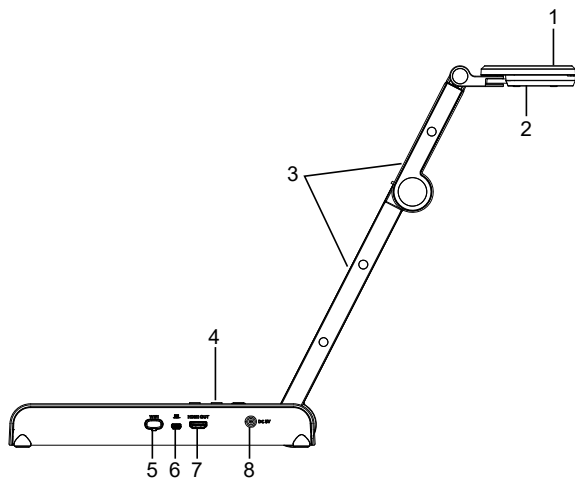

1. Testa della telecamera	2. Illuminazione LED
3. Braccio	4. Pannello di controllo
5. Dongle Wi-Fi	6. Porta USB
7. Uscita HDMI	8. Jack di alimentazione CC

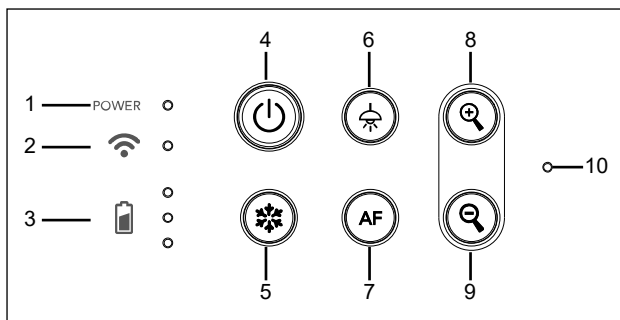

Pannello di controllo



- | | |
|---|-----------------------------|
| 1. Indicatore di alimentazione | 6. Lampada (on/off) |
| 2. Spia Wi-Fi | 7. Messa a fuoco automatica |
| 3. Spia batteria | 8. Ingrandimento |
| 4. Pulsante di alimentazione
(on/off/standby*) | 9. Rimpicciolimento |
| 5. Blocco | 10. MICROFONO integrato |

* La modalità standby è supportata quando l'alimentazione è collegata.

Spia LED

Alimentazione	Verde fisso: Alimentazione Nessuna spia Spegnimento Rosso fisso: Modalità standby* * La modalità standby è supportata quando l'alimentazione è collegata.
Wi-Fi 	Blu fisso Modalità AP Pronta / STA connesso Blu lampeggiante lento: Connessione del software con la telecamera Blu lampeggiante breve: Crea modalità AP / connessione STA Verde fisso: Modalità Miracast pronta Verde lampeggiante lento: Avvio streaming Miracast Verde lampeggiante veloce: Scansione dispositivo Miracast / connessione in corso
Batteria 	Verde fisso (x3): La batteria è carica (100% ~ 60%) Verde fisso (x2): La batteria è al 60% ~ 30% Verde fisso (x1): La batteria è al 30% ~ 5% Rosso fisso (x1): La batteria è al 5% ~ 0% Rosso lampeggiante (x1): La batteria è scarica Arancione fisso (x3): La batteria ha un comportamento anomalo

[Nota]

La batteria sarà completamente scarica per un utilizzo a lungo termine. Non sostituire la batteria da soli. Si prega di contattare il proprio rivenditore.

Chiave Composita

Tenere premuto per 3 secondi per azionare la funzione Chiave Composita.



MORE INFO / BATTERY : Visualizzare le informazioni del sistema e lo stato di carica della batteria.



CAPTURE : Istantanea dell'immagine dello schermo corrente su software o cloud.

Premere i tasti per azionare la funzione della Chiave Composita.

FACTORY RESET



+



: Ripristino alle impostazioni predefinite di fabbrica.

RESOLUTION



+



: Premere per passare da una modalità all'altra:

- Rileva automaticamente la risoluzione migliore (4K, 720P, 1080P)
- 1024x768 (Se supportato dal dispositivo HDMI)
- 4K 60Hz (se supportata dal dispositivo HDMI)

MODE



+



Premere per spostarsi fra le seguenti modalità:

- Normale: Regolare il gradiente dell'immagine.
- Movimento: Aumentare il frame rate. Quando si utilizza questa modalità è necessario disporre di un quantitativo sufficiente di luce.
- Alta qualità: Migliore qualità dell'immagine.

Collegamento del dispositivo

1 Inserire l'adattatore di alimentazione e accendere il dispositivo M15W.

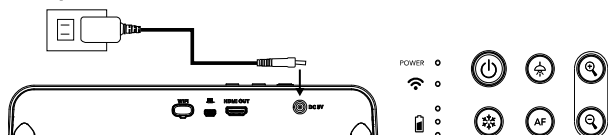

[Nota]

- Si prega di **caricare completamente la telecamera per il primo utilizzo.**
- **Quando** la telecamera è accesa, la telecamera si trova nella modalità **"Standby"**. In modalità standby, il caricamento può avvenire con il collegamento USB tra altri dispositivi, tuttavia l'alimentazione necessaria è 5V2A e il tempo di carica sarà più lungo.
- Il computer portatile, proiettore o monitor **non sono in grado** di fornire alimentazione tramite il collegamento USV mentre la telecamera è in funzione.
- Quando la fotocamera è in carica con la presa a muro, la spia della batteria è di colore verde lampeggiante.
- Premere **AF** + **Q** per riavviare quando la fotocamera non funziona correttamente.

2 Collegare il dispositivo M15W al computer portatile e al display HDMI.

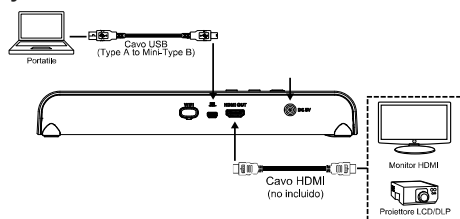



[Nota]

- La modalità Wi-Fi è attiva quando la telecamera viene accesa.
- Quando la telecamera si collega a un computer portatile tramite una porta USB, la modalità Wi-Fi viene disattivata. Si prega di attenersi alle indicazioni sul dispositivo HDMI.

Connessione P2P tramite Dongle Wi-Fi (Opzionale)

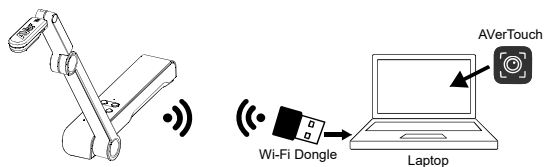
- 1 **Collegare il dongle Wi-Fi al PC/computer fisso e installare l'applicazione AVerTouch.**



- 2 **Aprire l'applicazione AVerTouch, fare clic su  per collegare la telecamera.**



[Nota] Controllare il numero seriale nella parte inferiore della telecamera per trovare la telecamera.

- 3 **Fare clic su Avanti per continuare.**

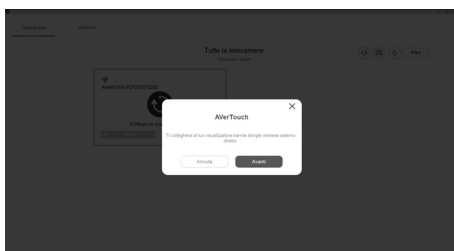

- 4 **Inserire il nome della telecamera e il codice di accesso, fare clic su Fatto per continuare.**



- 5 **Fare clic sul pulsante fatto per collegare la telecamera.**



[Nota] Il completamento della connessione richiede indicativamente 60 secondi.

- 6 **Selezionare X per uscire dalla pagina di visualizzazione in diretta.**



[Nota] Quando il collegamento va a buon fine, si dovrebbe vedere la vista in diretta della telecamera.

Connessione Wi-Fi

1 **Accendere la telecamera.**

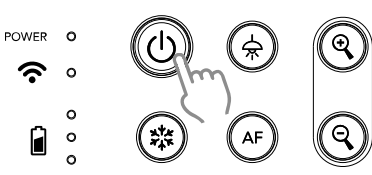

The diagram shows a control panel with several buttons. On the left, there are three status indicators: 'POWER', a Wi-Fi signal icon, and a battery icon. The main panel contains a power button (a circle with a vertical line), a camera icon, a search icon, a camera icon with a snowflake, and an 'AF' button. A hand is shown pressing the power button.

Controllare lo stato della Wi-Fi – Spia blu accesa.

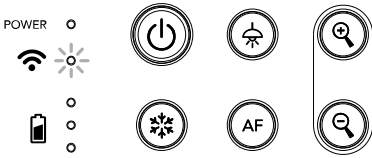

The diagram shows the same control panel as above, but the Wi-Fi signal icon is now lit up with a blue light, indicating that Wi-Fi is turned on.

2 **Aprire AVerTouch e seguire le istruzioni a video per attivare la funzione Wi-Fi sulla fotocamera.**



The screenshot shows the AVerTouch software interface. The main window displays a connection screen with a Wi-Fi icon and a camera icon. The text on the screen reads: 'AVERTOUCH (192.168.1.100)', 'Collega la tua telecamera', and 'AVERTOUCH'. There are also some status icons in the top right corner.

[Nota]

- Il software rileverà automaticamente la telecamera sulla rete.
- Selezionare la telecamera alla quale si desidera collegarsi.
- Il nome della telecamera sarà "AVer 'nome modello' - Mac address dongle Wi-Fi". Il Mac address sarà diverso rispetto al dispositivo.

3

Selezionare  per eseguire la connessione con la telecamera.

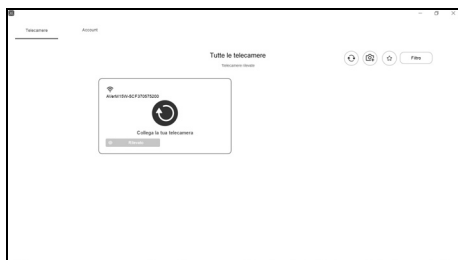

4

Selezionare  per passare alla schermata in diretta della telecamera.

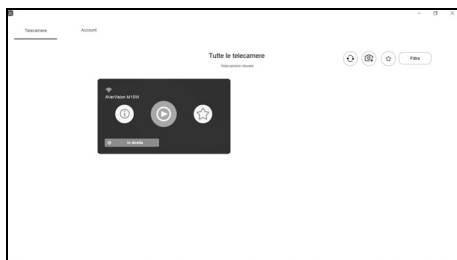

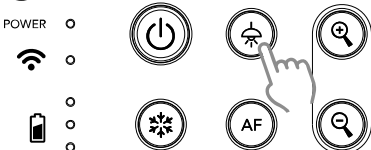

Connessione Miracast

1 Premere  per accedere al menu di selezione.



[Nota]

- Usare il pulsante  e  per andare alla selezione e premere il pulsante  per confermare la selezione.
- Un Dongle Miracast commerciale (Adattatore Wireless) è necessario per il dispositivo display.

2 Selezionare **Wireless > Modalità > Miracast** per attivare la modalità Miracast.

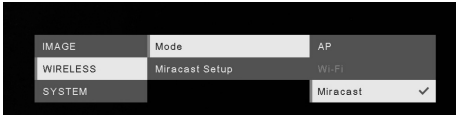

IMAGE	Mode	AP
WIRELESS	Miracast Setup	Wi-Fi
SYSTEM		Miracast ✓

3 Selezionare **Miracast > dispositivo di visualizzazione**.



IMAGE	Mode	A1561000308-33
WIRELESS	Miracast Setup	[LQ] webOS TV UK6...
SYSTEM		Cynap-01101591
		MD-20_BFAA0093

[Nota]

- I dispositivi display rilevati verranno elencati.
- Premere  per tornare indietro al menu.
- L'immagine della telecamera verrà visualizzata sullo schermo del dispositivo di visualizzazione solo dopo il collegamento.

Uso della telecamera

Archiviazione nella telecamera

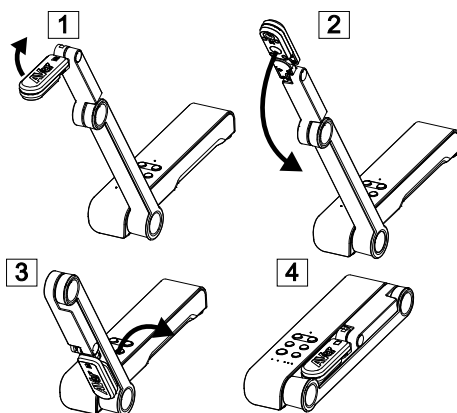

Uso dell'angolazione nella telecamera

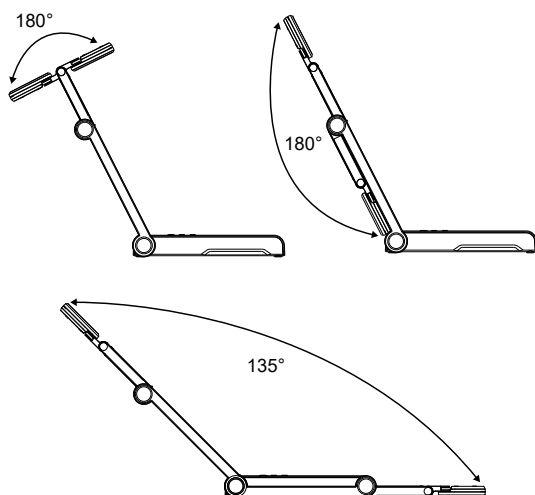

Montaggio della telecamera su una superficie piana

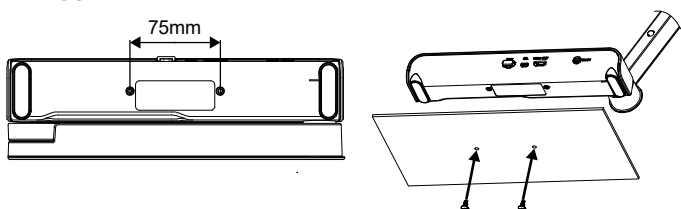

Rotazione della testa della telecamera

Spostare la testa della telecamera come indicato nell'immagine.

[ATTENZIONE] Per evitare di danneggiare la testa della telecamera, tenere il bordo della testa della telecamera per farla ruotare.

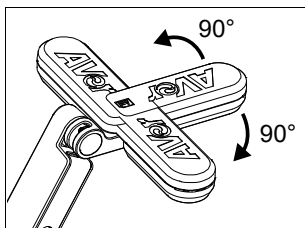

Area di ripresa

Quando la posizione della telecamera è alta 330 mm, l'area di ripresa sarà in formato A3. Posizionare l'oggetto come illustrato, l'immagine dell'oggetto è in direzione positiva.

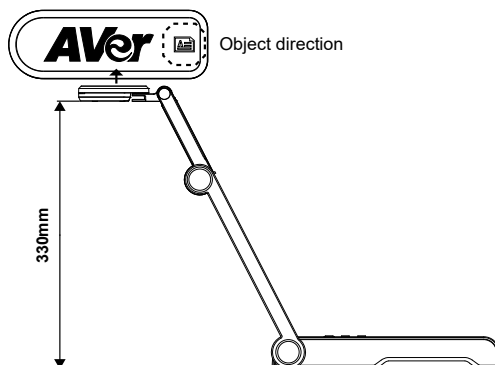

Direzione di ripresa dell'immagine

Per riprendere persone, regolare l'obiettivo della fotocamera come illustrato nella figura; l'immagine delle persone è in direzione positiva.

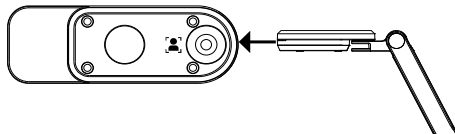

Specifiche tecniche

Sensore	1/3.06" CMOS	
Conteggio Pixel	13 megapixel	
Frame Rate	60 fps (max.)	
Modalità immagine	Normale / Alto numero di Frame / Elevata Qualità	
Effetto	Ruota / Blocca	
Uscita HDMI	4K / 1080p 60Hz; 720p 60Hz	
Messa a fuoco	Auto / Manuale / Area (SW)	
Area di ripresa	426mm x313mm @ 330 mm	
Ingrandimento/ Rimpicciolimento	Totale 23X massimo	
Modalità Doppia	AP / Stazione DHCP (Server/Cliente)	
Streaming Wi-Fi	1080P@30fps, fino a 4K@30fps	
Doppia banda	5GHz/2.4GHz	
Miracast	Sì	
Compatibilità	802.11a/b/g/n/ac (gamma effettiva 45 ft)	
Sicurezza wireless	SUPPORTA WEP, WPA/WPA2-PSK, WPA/WPA2-Enterprise* *EAP-PEAP, EAP-TLS	
Fonte di alimentazione	CC5V/ 2A, AC 100-240V	
Consumo	4 Watt (lampada accesa) 3.5 Watt (lampada spenta)	
Tipo di lampada	Spia LED	
USB	USB2.0 di Tipo-A (Dongle WiFi) USB di tipo mini-B x 1	
Ingresso CC 5V	Jack di alimentazione	
MIC	Integrato	
Funzionamento	518mm(lunghezza)*84 mm(larghezza)*351mm(altezza) (+/-2mm con piedini in gomma)	
Piegato	280mm(lunghezza)*84mm(larghezza)*42m m(altezza) (+/-2mm con piedini in gomma)	
Peso	0.68 kg (indicativamente 1.5 libbre)	
Software supportato	ePTZ Immagine / Area di cattura Immagine per immagine	Libreria cloud Registrazione in corso Annotazione Timer

INFORMATIVA

LE SPECIFICHE SONO SOGGETTE A VARIAZIONI SENZA PREAVVISO. LE INFORMAZIONI QUI CONTENUTE SONO PRESENTATE UNICAMENTE A SCOPO DI RIFERIMENTO.

COPYRIGHT

©2020 AVer Information Inc. Tutti i diritti riservati.

MARCHI COMMERCIALI

“AVer” è un marchio registrato da AVer Information Inc. Altri marchi commerciali qui usati unicamente a scopo descrittivo appartengono alle rispettive aziende.

ATTENZIONE

Rischio di esplosione se la batteria è sostituita con una di tipo errato. Smaltire le batterie usate a seconda delle istruzioni.

AVVERTENZA

- Non lasciar cadere la fotocamera e non sottoporla a urti fisici.
- Utilizzare la corretta tensione di alimentazione per evitare di danneggiare la telecamera.
- Non posizionare la fotocamera in un punto in cui il cavo possa essere calpestato, in quanto ciò potrebbe causare lo sfilacciamento o il danneggiamento del cavo o della spina.
- Non tirare il braccio meccanico e la parte della telecamera nella direzione opposta.
- Per ridurre il rischio di incendio o di scosse elettriche, non esporre questo dispositivo alla pioggia o all'umidità. La garanzia decade in caso di modifiche non autorizzate al prodotto.
- Tenere la parte inferiore della fotocamera con entrambe le mani per spostare la fotocamera. Non afferrare l'obiettivo o il braccio flessibile per spostare la fotocamera.

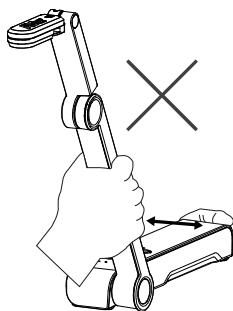
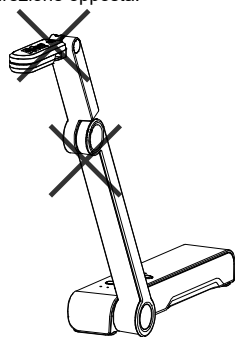

P/N: 300APW00-EGE